

ASSEMBLY INSTRUCTIONS

Step 1

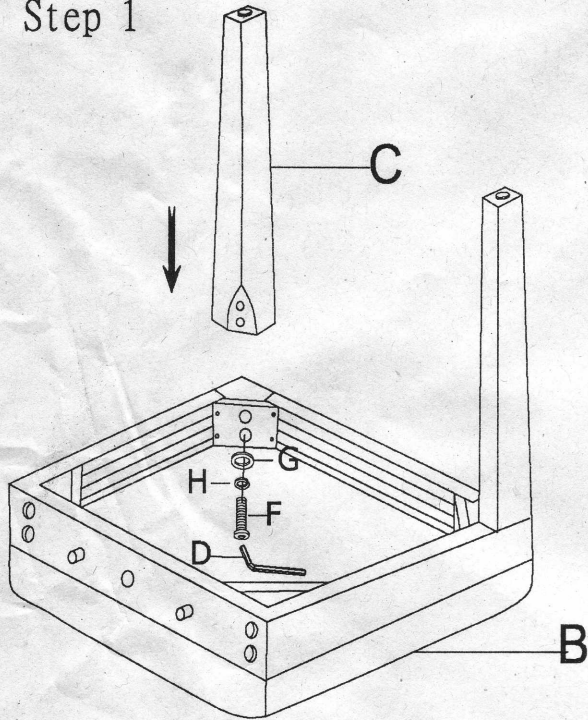

Parts List

NO.	DESCRIPTION	SKETCH	QTY
A	Backrest		1 PC
B	Cushion		2 PCS
C	Front Leg		1 PC

Hardware List

NO.	DESCRIPTION	SKETCH	QTY
D	Wrench 5mm		1 PC
E	Bolt $\varnothing 5/16$ "x3-1/2"		4 PCS
F	Bolt $\varnothing 5/16$ "x2"		5 PCS
G	Flat Washer $\varnothing 5/16$ "		9PCS
H	Spring Washer $\varnothing 5/16$ "		9PCS

Step 2

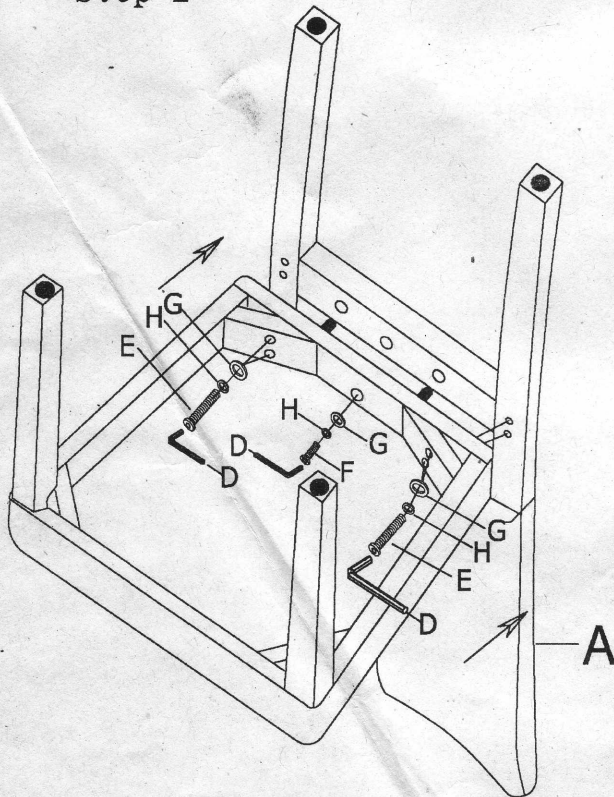

Step 3

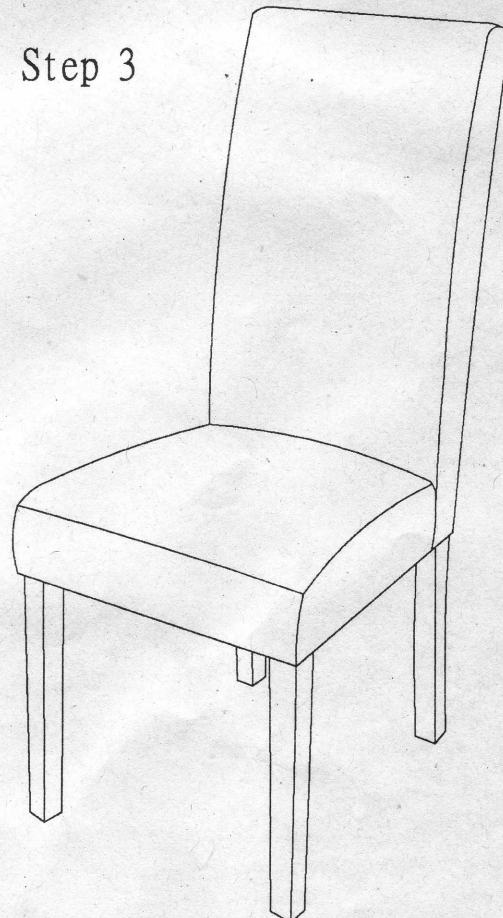

Do not tighten screws until completely Assembled

VERY IMPORTANT!! CARING INSTRUCTIONS

NEVER

USE GLASS CLEANERS ON
FINISHED FURNITURE AMMONIA
WILL CHEMICALLY ATTACK THE
LACQUER.

NEVER

ALLOW LIQUIDS OF ANY KIND TO
REMAIN IN DECORATIVE ROUTE LINES
ABSORPTION CAUSES WOOD TO WARP
AND FINISHES TO DE-LAMINATE



DO NOT
WRITE
DIRECTLY
ON
SURFACE

**PREVENT
MARKING**

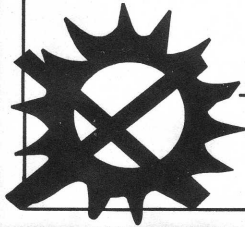

DO NOT
PLACE IN
DIRECT
SUNLIGHT

**PREVENT
FADING**

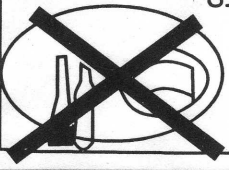

DO NOT
USE
RUBBER-
BASED
PLACEMATS
USE CLOTHS!

**PREVENT
DISCOLORING**

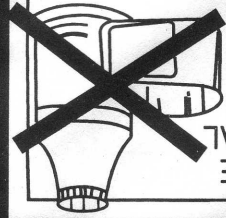

DO NOT USE
COMMERCIAL
WAXES AND
POLISHES

**PREVENT
YELLOWING**



DO NOT
PLACE HOT
KETTLES
POTS, ETC
ON
SURFACE

**PREVENT
DAMAGE TO
FINISH!**

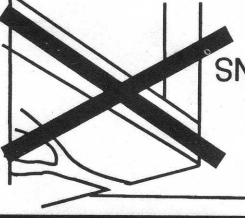

MAINTAIN
EVEN
HUMIDITY
CONDITIONS
IN YOUR
HOME

**PREVENT
SPLITTING**

TO CLEAN

SIMPLY USE A SOFT
CLOTH MOISTENED IN
LEMON OIL POLISH OR
LUKEWARM SOAP & WATER
THEN BUFF WITH A DRY
CLEAN CLOTH!

