

# VS511Z Wiring Configuration and DIP Switch Settings

## Setup (As Shipped)

- 240V Pump 1, 2-Speed
- 240V Pump 2, 2-Speed
- 120V Ozone
- 12V Spa Light
- 120V Circ Pump
- 120V A/V (Stereo)
- Duplex Main Panel

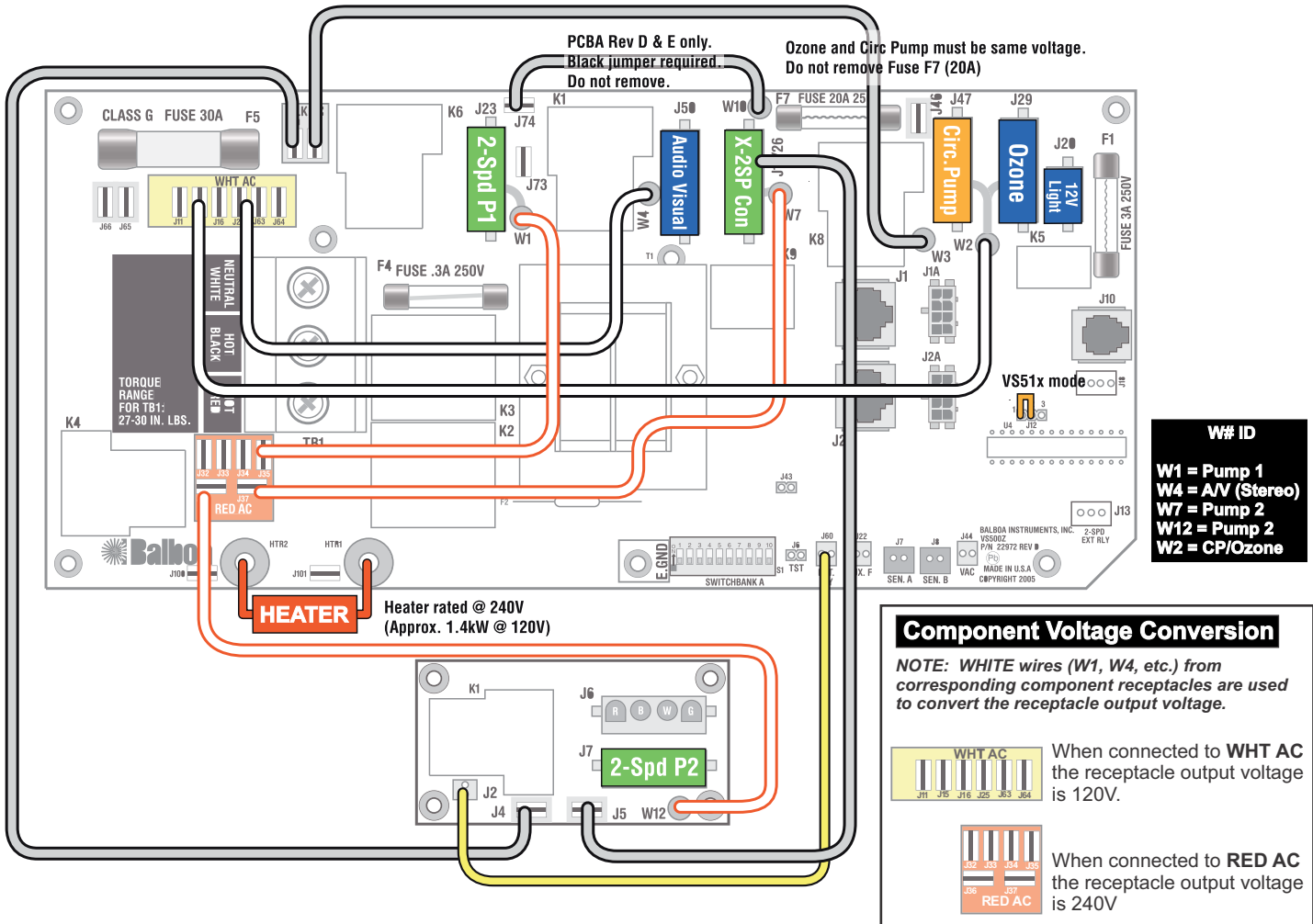

**WARNING:** Main Power to system should be turned OFF BEFORE adjusting DIP switches.  
**WARNING:** Persistent Memory (J43) must be RESET to allow new DIP switch settings to take effect. (See Persistent Memory page)

**SSID #**

100

67

43

### Switchbank A

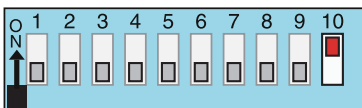

- A1, Test Mode OFF
- A2, See Table 1
- A3, Duplex Panel
- A4, Aux Freeze
- A5, 2-speed P1
- A6, 60 Hz
- A7, Mode changes allowed
- A8, Degrees F
- A9, Non-Circ Mode
- A10, See Table 1

### VS51x/VS5xxS/VS5xxD

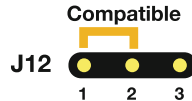

### Wiring Color Key

- 120 Volt Connections
- 240 Volt Connections
- Black AC Jumpers
- 12 Volt Connections
- Relay Control Wires

### Board Connector Key

- 1 Typically Line voltage
- 2 Typically Line voltage for 2-speed pumps
- 3 Neutral (Common)
- 4 Ground

Note flat sides in connector

### Panel Button Assignments

- 1=Pump 2
- 2=Pump 1
- 3=Temp
- 4=Light

### Panel Button Positions





# VS511Z DIP Switches and Jumpers Definitions

## SSID 100 67 43

## Base Model VS511Z

### DIP Switch Key

- A1 Test Mode (normally OFF)
- A2+A10 Control amp draw requirements (See Table 1)
- A3 "ON" position: use Mini Panel   
"OFF" position: use Digital Duplex or Light Duplex panel  
- A4 Aux Freeze (must be OFF)
- A5+A9 Pump 1 speeds and Circ Modes:

A2	A10	# of Hi-Speed Pumps/Blower Before Heat Disabled
OFF	OFF	0
ON	OFF	1
OFF	ON	2
ON	ON	3

A5	A9	Circ Mode	Pump 1 Speed
OFF	OFF	Non-circ	2-speed
ON	OFF	Circ "acts like Pump 1 low" (filters/polls/ect)	1-speed
OFF	ON	24 hours with 3°F shut-off	1-speed
ON	ON	24 hours with 3°F shut-off	2-speed

- A6 "ON" position: 50Hz operation  
"OFF" position: 60Hz operation
- A7 "ON" position: Standard mode only  
"OFF" position: Std/Ecn/Sleep mode changes allowed
- A8 "ON" position: temperature is displayed in degrees Celsius  
"OFF" position: temperature is displayed in degrees Fahrenheit

Note: Panel layout is always Pump 2, Pump 1, Temp, Light

### Jumper Key

- J12 Factory set. DO NOT MOVE.**  
Jumper must be on Pins 1 and 2 for VS51xZ/VS5xxSZ/VS5xxDZ software.  
Jumper must be on Pins 2 and 3 for VS50xZ software.
- J43** When jumper is placed on 2 pins during power-up, system will reset persistent memory.  
Leave on 1 pin only to enable persistent memory feature.

#### WARNING:

YSetting DIP switches incorrectly may cause abnormal system behavior and/or damage to system components.  
YRefer to Switchbank illustration on Wiring Configuration page for correct settings for this system.  
YContact Balboa if you require additional configuration pages added to this hot sheet.

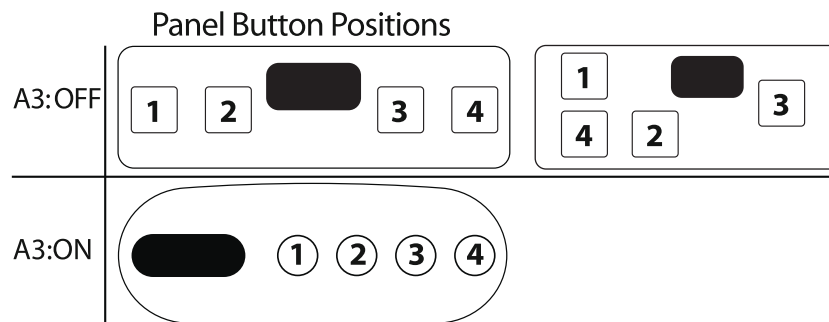

#### Panel Button Assignments

- 1=Pump 2
- 2=Pump 1
- 3=Temp
- 4=Light

# Balboa 500Z-Series Operation Guide

## Initial Start-up

Your spa will enter Priming Mode (*P<sub>r</sub>*) when it is energized. During Priming Mode, press “Jets” button(s) repeatedly and be sure all pumps are free of air. Priming Mode lasts less than 5 minutes. Press “Temp” to exit. After Priming Mode, the spa will run in Standard Mode (see Mode section). Some panels may not have a “Temp” button. On these panels the “Set,” “Warm,” or “Cool” buttons are used.

The pump responsible for heating and filtration (pump 1 low-speed on non-circ system, or the circ pump on circ systems) will be referred to simply as the pump.

In multi-button sequences, if the buttons are pressed too quickly in sequence, they may not register.



Button shapes and labels may vary.

### Temp Control (80°F - 104°F / 26°C - 40°C)

The last measured water temperature is constantly displayed.

The water temperature displayed is current only when the pump has been running for at least 2 minutes.

On panels with a single “Temp” or “Set” button, to display the set temperature, press the button once. To change the set temperature, press the button a second time before the display stops flashing. Each press of the button will continue to either raise or lower the set temperature. If the opposite direction is desired, allow the display to revert to the current water temperature. Press the button to display the set temperature, and again to make the temperature change in the desired direction.

On panels with “Warm” and “Cool” buttons, to display the set temperature, press “Warm” or “Cool” once. To change the set temperature, press a temperature button again before the display stops flashing. Each press of “Warm” or “Cool” will adjust the set temperature.

After three seconds, the display will stop flashing and begin to display the current spa temperature.

### Jets 1

Press “Jets 1” to turn pump 1 on or off, and to shift between low and high speeds (if equipped). The low-speed will turn off after 4 hours. High-speed will turn off after 15 minutes. Low-speed may run automatically at times, during which it cannot be deactivated from the panel, but high-speed may be operated.

### Jets 2/Jets 3/Blower (If equipped)

Press the corresponding button once to turn the device on or off. The device will turn off after 15 minutes. Pump 2 may be two-speed on some systems.

Some systems use this one button to control two devices. The first button press will activate one device. Press again to have both devices active. Press again to turn off the first device only. Press one more time to turn both devices off.



This document covers VS and GS systems 500Z through 521Z with Balboa Panels VL200 through VL406.  
<http://www.balboawatergroup.com/>

### Light

Press “Light” to operate the spa light. Turns off after 4 hours.

## Mode

Depending on system configuration, mode changing may not be available and will be locked in Standard Mode.

Mode is changed by pressing “Temp,” then “Light”.

**Standard Mode** maintains set temperature. *5t* will be displayed momentarily when you switch into Standard Mode.

**Economy Mode** heats the spa to the set temperature only during filter cycles. *Et* will display when water temp is not current, and will alternate with water temp when the pump is running.

**Sleep Mode** heats the spa to within 20°F/10°C of the set temperature only during filter cycles. *5L* will display when water temp is not current, and will alternate with water temp when the pump is running.

## Preset Filter Cycles

The first preset filter cycle begins 6 minutes after the spa is energized. The second preset filter cycle begins 12 hours later.

Filter duration is programmable for 2, 4, 6, or 8 hours or for continuous filtration (indicated by *FL*). The default filter time is 2 hours for non-circ systems and 4 hours for circ systems.

To program, press “Temp,” then “Jets 1.” Press “Temp” to adjust. Press “Jets 1” to exit programming.

**For non-circ systems**, low-speed pump 1 and the ozone generator (if installed) run during filtration.

**For 24 hour circulation systems**, the circ pump and the ozone generator (if installed) run 24 hours. In hot environments, the circ pump may turn off for 30 minute periods, except during filter cycles.

**For non-24 hour circulation systems**, the circ pump and ozone generator (if installed) run during filtration (and may also run automatically at other times).

**At the beginning of each filter cycle** all other equipment will run briefly to purge the plumbing.

## Automatic polling (in Standard Mode only)

The pump will activate for 1 to 2 minutes to check the temperature:

- every 30 minutes
- whenever any other pump or blower is turned on
- whenever the set temperature is raised

## Diagnostic Messages

Message	Meaning	Action Required
--	No message on display. Power has been cut off to the spa.	The control panel will be disabled until power returns. Spa settings will be preserved until next power up.
--	Temperature unknown.	After the pump has been running for 2 minutes, the current water temperature will be displayed.
HH	“Overheat” - The spa has shut down.* One of the sensors has detected 118°F/47.8°C at the heater.	DO NOT ENTER THE WATER. Remove the spa cover and allow water to cool. Once the heater has cooled, reset by pushing any button. If spa does not reset, shut off the power to the spa and call your dealer or service organization.
OH	“Overheat” - The spa has shut down.* One of the sensors has detected that the spa water is 110°F/43.5°C.	DO NOT ENTER THE WATER. Remove the spa cover and allow water to cool. At 107°F/41.7°C, the spa should automatically reset. If spa does not reset, shut off the power to the spa and call your dealer or service organization.
SA	Spa is shut down.* The sensor that is plugged into the Sensor “A” jack is not working.	If the problem persists, contact your dealer or service organization. (May appear temporarily in an overheat condition.)
Sb	Spa is shut down.* The sensor that is plugged into the Sensor “B” jack is not working.	If the problem persists, contact your dealer or service organization. (May appear temporarily in an overheat condition.)
Sn	Sensors are out of balance. If alternating with spa temperature, it may just be a temporary condition. If flashing by itself, spa is shut down.*	If the problem persists, contact your dealer or service organization.
HL	A significant difference between temperature sensors has been detected. This could indicate a flow problem.	If the water level is normal, make sure all pumps have been primed. If problem persists, contact your dealer or service organization.
LF	Persistent low flow problems. (Displays on the fifth occurrence of HL message within 24 hours.) Heater is shut down, but other spa functions continue to run normally.	Follow action required for HL message. Heating capability of the spa will not reset automatically; you may press any button to reset.
dr	Possible inadequate water, poor flow, or air bubbles in detected in the heater. Spa is shut down for 15 minutes.	If water level is normal, make sure all pumps have been primed. Press any button to reset. This message will reset within 15 minutes. If problem persists, contact your dealer or service organization.
dy	Inadequate water detected in heater. (Displays on third occurrence of dr message.) Spa is shut down.*	Follow action required for dr message. Spa will not automatically reset. Press any button to reset manually.
IC	“Ice” - Potential freeze condition detected.  * - Even when spa is shut down, some equipment will turn on if freeze protection is needed.	No action required. All equipment will automatically activate regardless of spa status. The equipment stays on 4 minutes after the sensors detect that the spa temperature has risen to 45°F/7.2°C or higher. An optional freeze sensor may be added to protect against extraordinary freeze conditions. Auxiliary freeze sensor protection is advisable in colder climates. See your dealer for details.

## Warning! Shock Hazard! No User Serviceable Parts.

Do not attempt service of this control system. Contact your dealer or service organization for assistance. Follow all owner's manual power connection instructions. Installation must be performed by a licensed electrician and all grounding connections must be properly installed.