

# ASSEMBLY INSTRUCTION

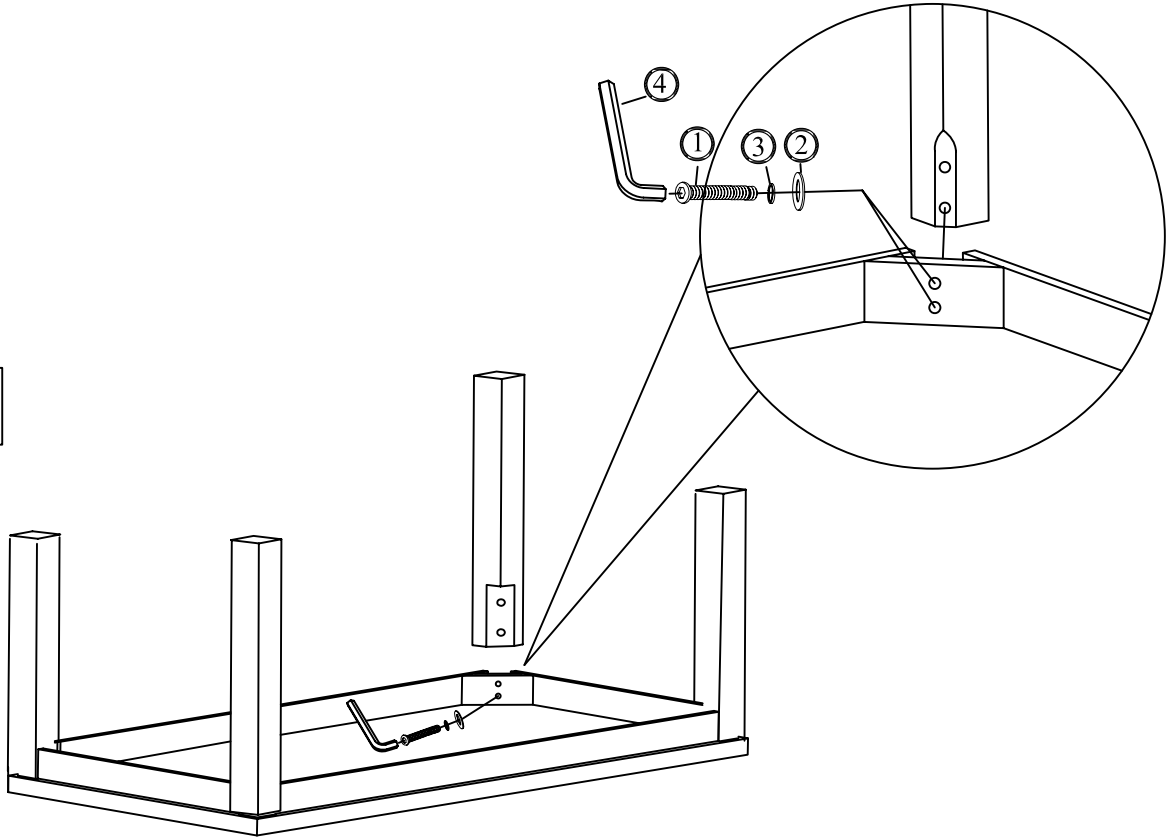



22450-57 MAYFAIR 36x60 TABLE

1

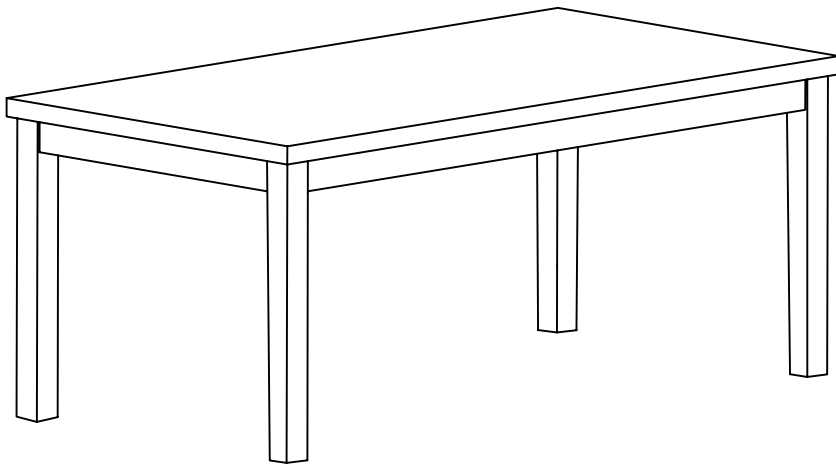



2

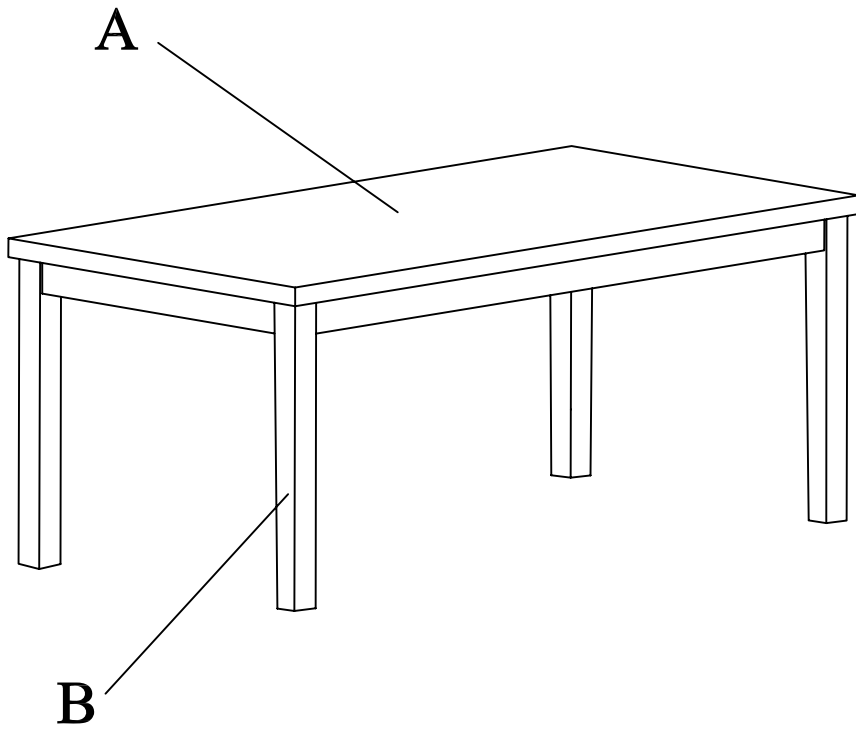

①		Ø5/16"* 2-1/2"	8PCS
②		Ø5/16"	8PCS
③		Ø5/16"* Ø25mm	8PCS
④		Ø5/16"	1PC

DO NOT TIGHTEN SCREWS UNTIL COMPLETELY ASSEMBLED

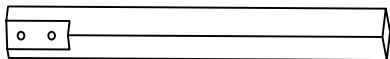

<b>A</b>		<b>TOP</b>	<b>1PC</b>
<b>B</b>		<b>LEG</b>	<b>4PCS</b>