

DIESEL SPACE HEATER - SERVICE MANUAL

INDEX

1. CONTROLS AND COMPONENTS
2. FLAME CONTROL CYCLES
3. MAINTENANCE SCHEDULE
4. TROUBLESHOOTING GUIDE
5. REPAIR PROCEDURES
 1. FAN MOTOR ASSEMBLY
 2. FUEL FILTER ASSEMBLY
 3. FUEL PUMP ASSEMBLY
 4. ELECTRIC PANEL ASSEMBLY
 5. AIR PRESSURE SWITCH
 6. COMBUSTION HEAD ASSEMBLY
 7. COMBUSTION CHAMBER
 8. COMBUSTION TEST
6. WIRING DIAGRAMS
7. TECHNICAL SHEETS

EC 100 – EC 100 PT

L-S 101.01-BM



WARNING

The operations described in this booklet must be carried out by qualified and instructed personnel only. Incorrect maintenance may result in improper operation and serious injury.

1. CONTROLS AND COMPONENTS

INDIRECT HEATER WITH STACK AND METAL FUEL TANK: EC 100

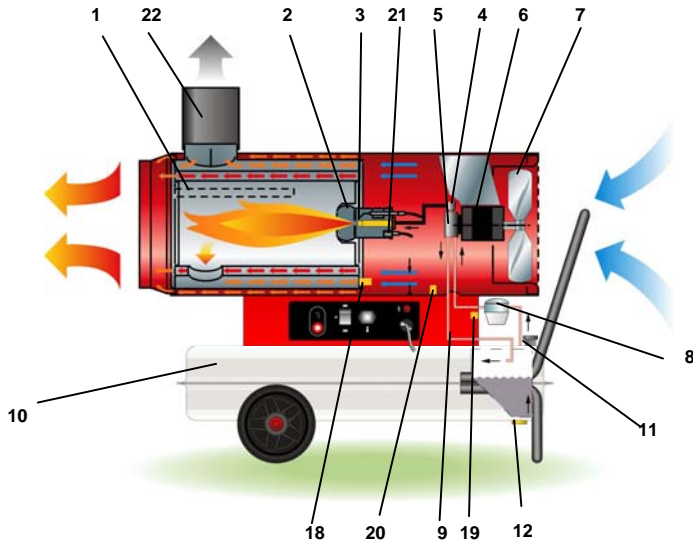

- 1 COMBUSTION CHAMBER
- 2 BURNER ASSEMBLY
- 3 NOZZLE
- 4 FUEL VALVE
- 5 DIESEL PUMP
- 6 MOTOR
- 7 FAN
- 8 FUEL FILTER
- 9 FUEL CIRCUIT
- 10 FUEL TANK
- 11 FUEL TANK PLUG
- 12 DRAIN PLUG
- 13 RESET BUTTON/LAMP OF CONTROL FLAME
- 14 MAIN SWITCH
- 15 ROOM THERMOSTAT PLUG
- 16 CONTROL LAMP
- 17 POWER CORD
- 18 OVERHEAT THERMOSTAT
- 19 AIR PRESSURE SWITCH GAUGE (LOW PRESSURE SIDE)
- 20 AIR PRESSURE SWITCH GAUGE (HIGH PRESSURE SIDE)
- 21 FLAME DETECTOR (PHOTOCELL)
- 22 STACK

INDIRECT HEATER WITH STACK AND PLASTIC FUEL TANK: EC 100PT

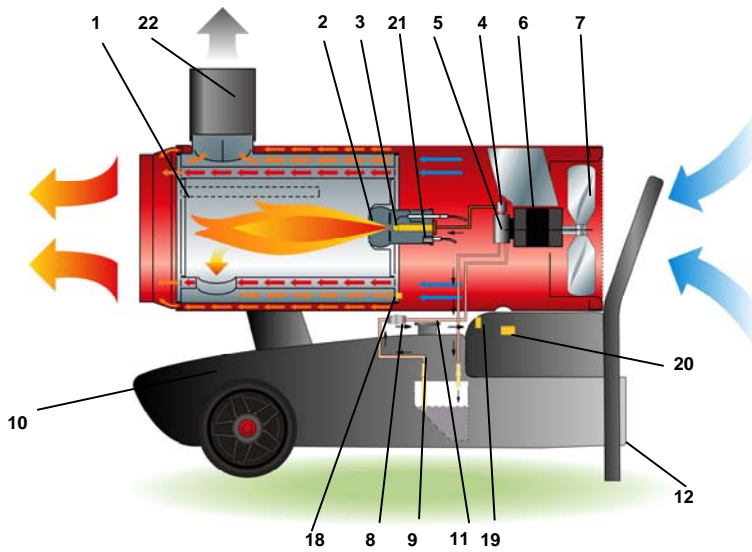

CONTROL PANEL

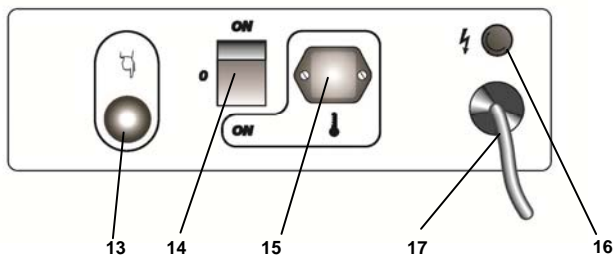

CONTROL SYSTEM

The heater has all operational controls located in a watertight control panel mounted on a lateral side of the unit (EC 100) or rear side of the unit (EC 100PT).

The control panel consists of:

- a 3-position switch for heating function: normal operation, stop or thermostat operation
- plug to connect a remote room thermostat
- power cord
- control flame box to handle starting / running cycle (see paragraph 2.).

The control flame box is equipped with a reset button and a high voltage transformer that generates a spark to ignite the flame.

The control system utilizes:

- a safety shut off switch that is a overheat thermostat shutting down the unit if the temperature of combustion chamber and outlet air exceed the maximum allowed level
- an air pressure switch, that stops the unit if the air flow is not sufficient for combustion.
- a flame detector, that is a photocell monitoring constantly the flame presence and its integrity.
- a pair of ignition rods to create the ignition spark

FUEL SYSTEM

The fuel system consists of:

- fuel tank, that can be made of:
 - steel, corrosion proof (EC 100) or
 - plastic, shock absorption and fuel resistant (EC 100PT)Both types of fuel tanks have a drain plug located underneath the fuel tank to allow discharge of residual fuel before cleaning.
- fuel filter
- fuel pump. A screw fitted on the fuel pump allows the adjustment of fuel pressure setting
- fuel ON/OFF solenoid valve
 - during normal operation the valve is open and the pressurized fuel flows to the nozzle, where it is atomized, mixed with primary combustion air and ignited by the electrode spark
 - during abnormal operation (see paragraph 2.) the flame control unit closes the fuel solenoid valve and the unit stops.
- fuel circuit, including suction and return hoses from fuel tank to fuel pump and high pressure microhose from fuel pump to nozzle
- burner head
- nozzle

COMBUSTION CHAMBER

It consists of:

- the internal combustion chamber (stainless steel made) that containing the flames and
- the external high efficient heat exchanger (aluminated steel made), that leads smokes to chimney / stack.

BURNER HEAD

The burner head is the assembly that determines the correct mixing of combustion air and fuel inside the combustion chamber and it consists of:

- Fuel nozzle
- Nozzle support
- Flame diffuser
- Air opening baffle: a screw fitted on the burner head allows the adjustment of combustion air setting
- Ignition electrodes
- Flame detector







FAN – MOTOR ASSEMBLY

The electric motor drives the fuel pump assembly and a fan which blows air inside and around combustion chamber.

2. FLAME CONTROL CYCLES

2.1 RESET LAMP LIGHT

During the operating condition, the reset button may have different type of light depending of its operating status (FUNCTION LIGHT):

-  flashing green: unit is in stand-by status, waiting for heating request.
-  steady green light: unit is working normally (starting cycle or working cycle)
-  steady orange light: the heater stops temporarily to allow H.T. transformer cooling down and automatically restarts when the time has passed
-  flashing orange: presence of extraneous flame in stand-by status (waiting for heating request)
-  flashing green / orange: presence of extraneous flame in prepurge time
-  steady red light: the heater stops permanently in lock-out status and can restart only if reset button is pressed.

To troubleshooting the unit when it is in lock-out condition, press the reset button for about 10 seconds and then release it. A diagnostic routine is enabled, causing the reset button on the main board to flash (SELF-DIAGNOSIS LIGHT) with the following description

	Number of blinks	Fault description
	2	Flame failure in starting cycle
	4	Extraneous light / flame in starting cycle
	7	Flame failure in running cycle
	8 - 14	Internal failure of electronic control

2.2 OPERATING CYCLES

Depending on the type of the operating cycles, the main components (room thermostat, fan, ignition transformer, fuel valve) and controls element (photocell, reset button) are activated or de-activated according to specific rules and times.

In the following diagrams are shown

- Starting cycle
- Shut off cycle
- Flame failure in starting cycle
- Extraneous light or flame during starting cycle
- Flame failure in running cycle

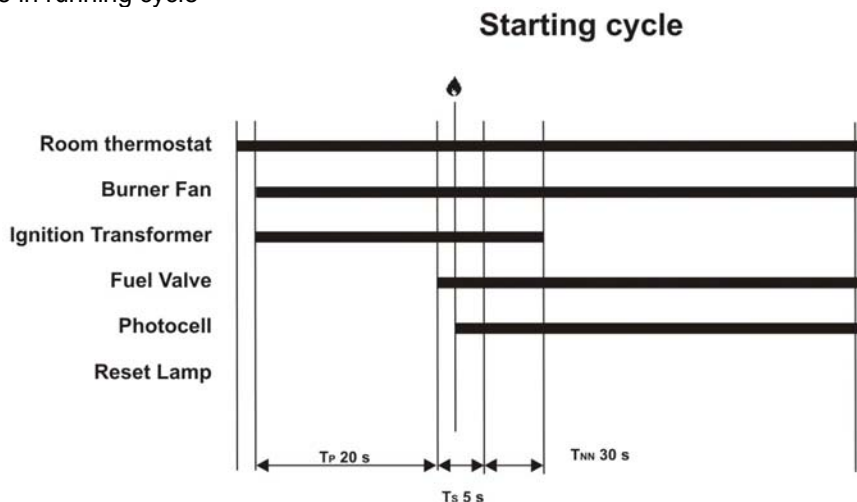

The flame control unit starts the sequence of operation after a heating request (normal operation or thermostat operation) and it consists of the following steps:

- Self-test (less than 3 s): self-check of electronics efficiency;
- Purging time T_P (20 seconds): fan motor and ignition transformer are simultaneously switched on while the fuel valve remains closed to eliminate any fuel or unburnt residual.

During the purging stage, the flame signal is constantly monitored and any kind of failure leading to combustion prevents the burner ignition causing the controls to lock out the unit.

In case of heating request opening (room thermostat opening), the control unit goes to stand-by position. The device remains in this status till closing of the room thermostat;

- Safety time (5 seconds): at the end of the purging time T_P , the fuel valve is switched on and opens the fuel to the nozzle.

In case of flame detection failure by the end of the T_S safety time, the control unit goes to lockout, and the fan motor, the ignition transformer and the fuel valve are de-energized, while the lockout signal is enabled.

Otherwise, at the end of the T_S safety time the control unit disables the ignition transformer and goes to running position.

- At the end of the T_S safety time the control unit keeps the ignition transformer operating for about 30 s.

Shut off /cooling cycle (thermostat opens)

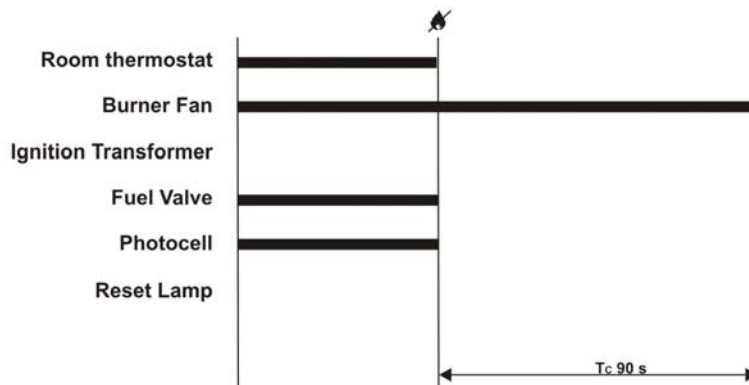

When the heating request (normal operation or thermostat operation) opens:

- fuel valve and ignition transformer are switched off and the flame lights off;
- burner fan operates a 90 s post-purge ventilation

Restoring the heating request causes the post-purge to be interrupted and the starting cycle to be performed.

Flame failure in starting cycle (two trial recycling)

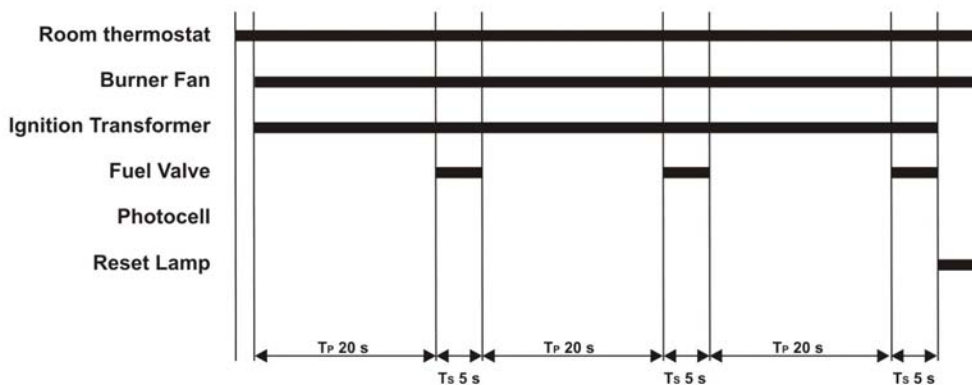

If during the safety time T_s , the photocell monitors a flame failure (signal to photocell become lower than minimum), at the end of safety time the unit tries to restart twice: should the flame failure being confirmed, then the unit goes in lock out:

- burner fan, ignition transformer and fuel valve are de-energized;
- alarm lamp on reset button becomes steady red

If troubleshooting on reset button is activated as described in 2.1, then the alarm lamp on reset button starts flashing with 2 blinks.

FUNCTION LIGHT: steady red

SELF-DIAGNOSIS LIGHT: flashing red with 2 blinks

Unit can re-start only after pressing the reset button.

NOTE: While starting cycle is repeated, a cooling time T_{XP} is required to get the ignition transformer be ready to operate.

Extraneous light / flame during pre-purge time T_p

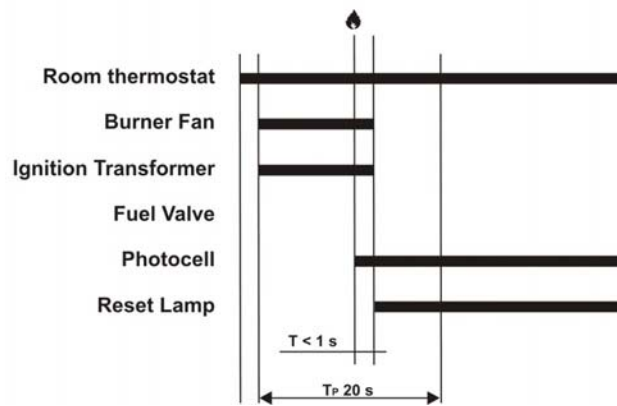

If during the pre-purge time the photocell monitors any residual flame then the unit goes in lock out:

- burner fan stop to purging combustion chamber
- fuel valve and ignition transformer are de-energized
- reset lamp becomes steady red

If troubleshooting on reset button is activated as described in 2.1, then the alarm lamp on reset button starts flashing with 4 blinks.

FUNCTION LIGHT: orange/green flashing then steady red

SELF-DIAGNOSIS LIGHT: flashing red with 4 blinks

Unit can re-start only after pressing the reset button.

Flame failure in running cycle (one trial recycling)

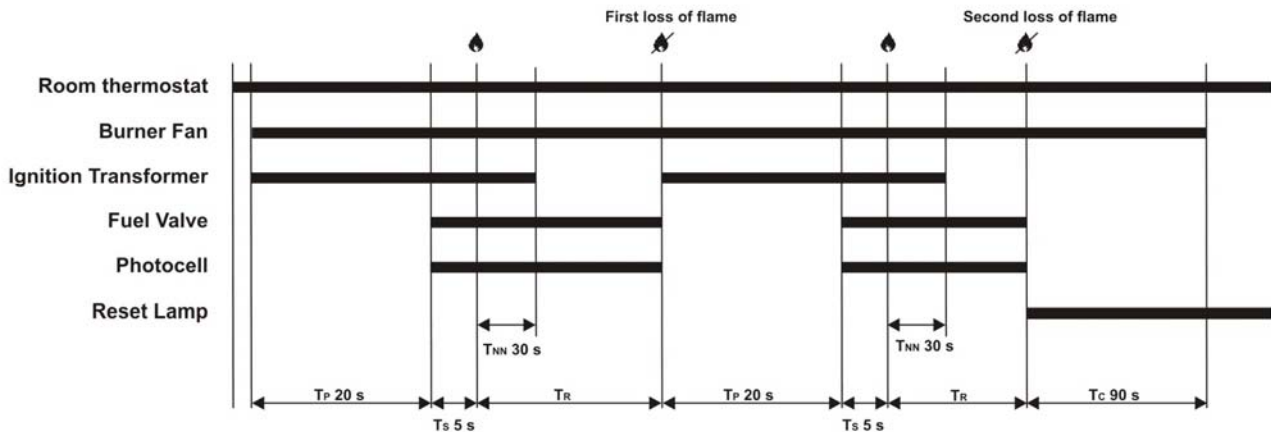

In case of flame failure in running status, the flame control unit make one trial restarting the unit.

If the reason of flame failure is confirmed, then the unit stops in lock-out mode, and the reset lamp becomes steady red.

If troubleshooting on reset button is activated as described in 2.1, then the alarm lamp on reset button starts flashing with 7 blinks.

FUNCTION LIGHT: steady red

SELF-DIAGNOSIS LIGHT: flashing red with 7 blinks

Unit can re-start only after pressing the reset button.

3. MAINTENANCE SCHEDULE

Periodic maintenance of the heater is necessary to ensure proper performance and to prevent failures and it shall be performed at the following periodic intervals:

- **Daily maintenance**
 - i. Inspect air inlet / air outlet and exhaust stack, remove debris if any
 - ii. If any air hose is installed, secure it is fixed. Minimize bends and keeps ducts straight
 - iii. Verify fuel tank is full
 - iv. Verify that exhaust stack is properly installed
- **Weekly maintenance**
 - i. Disassemble, inspect and clean fuel filter with clean fuel
 - ii. Remove top cover and clean the motor, fan blade and the interior shell
 - iii. Inspect the fuel hose assembly and check for any leaks
- **6 months maintenance**
 - i. Disassemble burner head
 - 1. Inspect and clean burner diffuser
 - 2. Inspect and replace nozzle if necessary
 - 3. Clean ignition electrodes and adjust settings
 - 4. Check air combustion setting
 - ii. Check overheat thermostat
 - iii. Inspect and clean the combustion chamber
 - iv. Open electric board, inspect electrical components and check connections
 - v. Check fuel pressure setting of fuel pump
 - vi. Inspect and test the burner

4. TROUBLESHOOTING GUIDE

PROBLEM	RESET BUTTON (13)		CAUSE	REMEDY		
• Motor does not start, no ignition	FUNCTION LIGHT	• Off	-	<ul style="list-style-type: none"> • No electrical current 	<ul style="list-style-type: none"> • Check mains • Check proper positioning and functioning of switch • Check fuse 	
			Flashing green	-	<ul style="list-style-type: none"> • Wrong setting of room thermostat or other control • Defective thermostat or other control 	<ul style="list-style-type: none"> • Check correct setting of heater control. If thermostat, make sure selected temperature is higher than room temperature • Replace control device
			Steady Orange	-	<ul style="list-style-type: none"> • H.T. transformer is cooling 	<ul style="list-style-type: none"> • Heater restarts automatically after cooling is completed
• Fan does not start or stops during start-up or heating	FUNCTION LIGHT	• Off	-	<ul style="list-style-type: none"> • Voltage below 68 V • Voltage above 147V 	<ul style="list-style-type: none"> • Check supply voltage: heater will restart automatically when voltage exceeds 78 V • Check supply voltage: heater will restart automatically when voltage is below 138 V 	
			Flashing orange and green	-	<ul style="list-style-type: none"> • Presence of extraneous flame in prepurge time 	<ul style="list-style-type: none"> • Clean and eliminate diesel residue in combustion chamber
• Fan stops during start-up or heating	FUNCTION LIGHT	• Steady red	SELF-DIAGNOSIS LIGHT	4 blinks	<ul style="list-style-type: none"> • Presence of flame before transformer ignites • Defective photocell 	<ul style="list-style-type: none"> • Clean and eliminate diesel residue in combustion chamber • Replace photocell
				2 blinks or 7 blinks	<ul style="list-style-type: none"> • Defective electrical motor 	<ul style="list-style-type: none"> • Replace electrical motor
					<ul style="list-style-type: none"> • Defective electrical motor bearings 	<ul style="list-style-type: none"> • Replace electrical motor bearings
					<ul style="list-style-type: none"> • Burned out condenser 	<ul style="list-style-type: none"> • Replace condenser
					<ul style="list-style-type: none"> • Defective electric ignitor 	<ul style="list-style-type: none"> • Check connection of H.T. wires to electrodes and transformer • Check electrodes setting (see scheme "SETTING THE ELECTRODES") • Check electrodes for cleanliness
						<ul style="list-style-type: none"> • Replace H.T. transformer
						<ul style="list-style-type: none"> • Defective flame control box
					<ul style="list-style-type: none"> • Defective photocell 	<ul style="list-style-type: none"> • Clean or replace photocell
					<ul style="list-style-type: none"> • Insufficient or no air to burner 	<ul style="list-style-type: none"> • Check fan motor • Check air pressure switch and air pipes connection
					<ul style="list-style-type: none"> • Insufficient or no fuel to burner 	<ul style="list-style-type: none"> • Check state of motor-pump plastic coupling • Check for any air infiltrations in the fuel line by checking the air-tightness of the pipes and of the filter. • Clean or replace oil nozzle
<ul style="list-style-type: none"> • Check electrical connection • Check thermostat LI 						
<ul style="list-style-type: none"> • Defective solenoid • Defective electric ignitor 	<ul style="list-style-type: none"> • Clean solenoid valve and replace it if necessary 					
8 – 14 blinks	<ul style="list-style-type: none"> • Internal error of electronic control board 	<ul style="list-style-type: none"> • Reset the device and attempt at least two starts. If the problem persists, replace the electronic control board 				
• Fan starts and flame lights, generating fumes	FUNCTION LIGHT	• Off	SELF-DIAGNOSIS LIGHT	-	<ul style="list-style-type: none"> • Insufficient combustion air 	<ul style="list-style-type: none"> • Check the position of the air regulation ring • Clean burner disc
					<ul style="list-style-type: none"> • Excess combustion air 	<ul style="list-style-type: none"> • Check the position of the air regulation ring
					<ul style="list-style-type: none"> • Fuel contaminated or contains water 	<ul style="list-style-type: none"> • Drain fuel in tank and load with clean fuel • Replace oil filter
					<ul style="list-style-type: none"> • Air leaks in fuel circuit 	<ul style="list-style-type: none"> • Check the seals on the ducts
					<ul style="list-style-type: none"> • Insufficient fuel at burner 	<ul style="list-style-type: none"> • Check pump pressure • Clean or replace fuel nozzle
					<ul style="list-style-type: none"> • Excess fuel at burner 	<ul style="list-style-type: none"> • Check pump pressure • Replace nozzle
• Heater does not stop	FUNCTION LIGHT	• Off	SELF-DIAGNOSIS LIGHT	-	<ul style="list-style-type: none"> • Defective solenoid seal 	<ul style="list-style-type: none"> • Replace complete solenoid valve

5. REPAIR PROCEDURES



WARNING

Before carrying out any maintenance operation the heater must be disconnected from power supply. Refer to instruction manual to fully stop the heater. Therefore:

- Stop the machine as instructed
- Turn off the disconnecting switch on the main electric switchboard
- Wait until the heater has cooled.

Never service heater while it is plugged in, operating or hot.
Severe burns or electrical shock can occur.

1) FAN MOTOR ASSEMBLY



- a) To clean the fan blades and motor, carry out the following procedure.
- i) Remove the air inlet grille (a) by removing four screws that secure it to the machine.
 - ii) Remove the top cover access panel (b) by removing six screws
 - iii) Inspect and, if necessary, clean the motor using compressed air, being carefully not to direct the air jet to the air pressure switch gauge (c) (the pressure switch could be damaged)

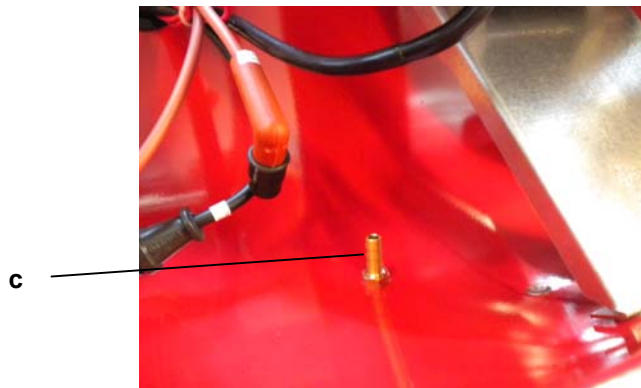

- iv) Clean the fan blades using a stiff brush.
- v) Reinstall the internal access panel.
- vi) Reinstall the fan grille.

- b) To replace the fan blade and the electric motor, carry out the following procedure.
- i) Remove the air inlet grille (a) by removing four screws that secure it to the machine.
 - ii) Loosen the screw (d) on the fan hub

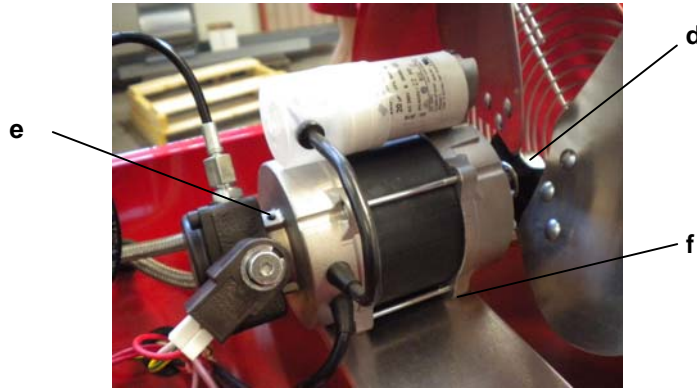

- iii) Extract the fan blades and replace with a new one respecting blades orientation
- iv) Remove the top cover access panel (b) by removing six screws
- v) Loosen three screws (e) on the fuel pump casing (be sure not to remove the screws)
- vi) Remove fuel pump from electric motor and keep plastic coupling for next reassembling
- vii) Loosen and remove four screws (f) that fix the motor on the motor flange
- viii) Open main electric board on side/front of the heater
- ix) Trace the electric motor power cords and disconnect the three wires (white, black, green) from control panel
- x) Position a new motor on the motor flange and reassemble four screws (f) to fix it
- xi) Check alignment of the motor to the heater axis and tighten four screws (f) on motor flange
- xii) Reassemble fuel pump on electric motor being sure that plastic coupling is aligned
- xiii) Tighten three screws (e)
- xiv) Position fan blade on the motor shaft being sure there is no interference with any parts when rotating
- xv) Tighten screw (d) and check free rotation of the fan blades
- xvi) Reinstall the fan grille and the top cover.

2) FUEL FILTER ASSEMBLY

a) To clean / replace the pre-heated type fuel filter, carry out the following procedure.

i) Remove the screw (a) that secures the cover to the housing and remove o-ring (b)

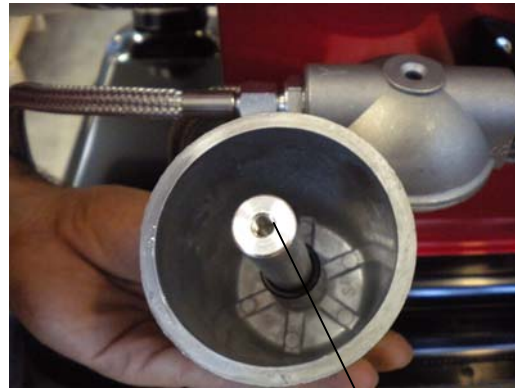
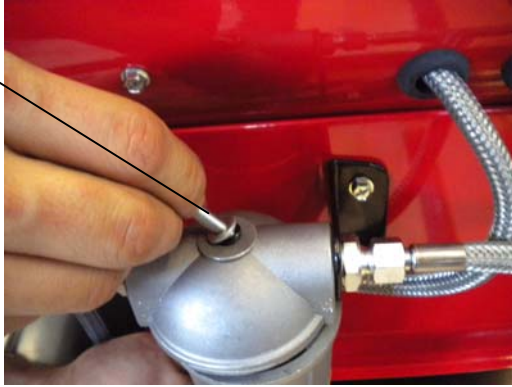

ii) Using a suitable container, collect the fuel when removing from the fuel filter assembly

iii) Remove the fuel cell (c) and wash it with clean diesel oil

iv) If necessary replace the fuel cell (c)

v) If necessary to replace the heating element, loosen the nut (d) and remove the electric resistance (e)

vi) Inspect the o-ring, replace it if it is cracked, damaged, or deformed

vii) Reassemble the filter assembly checking the o-ring is placed in the right position

viii) Tighten screw (a)

b) To clean / replace the standard type fuel filter, carry out the following procedure.

i) Loosen the casing (a) that secures to the housing



ii) Using a suitable container, collect the fuel when removing from the fuel filter assembly

iii) Remove fuel cell (c) and o-ring (b) and wash with clean diesel oil

iv) If necessary replace the fuel cell (c)

v) Inspect the o-ring, replace it if it is cracked, damaged, or deformed

vi) Reassemble the filter assembly checking the o-ring is placed in the right position

vii) Tighten casing (a) by hand, checking the o-ring is pressed

c) To replace the plastic type fuel filter, carry out the following procedure.

i) Remove clips (a) and fuel hoses

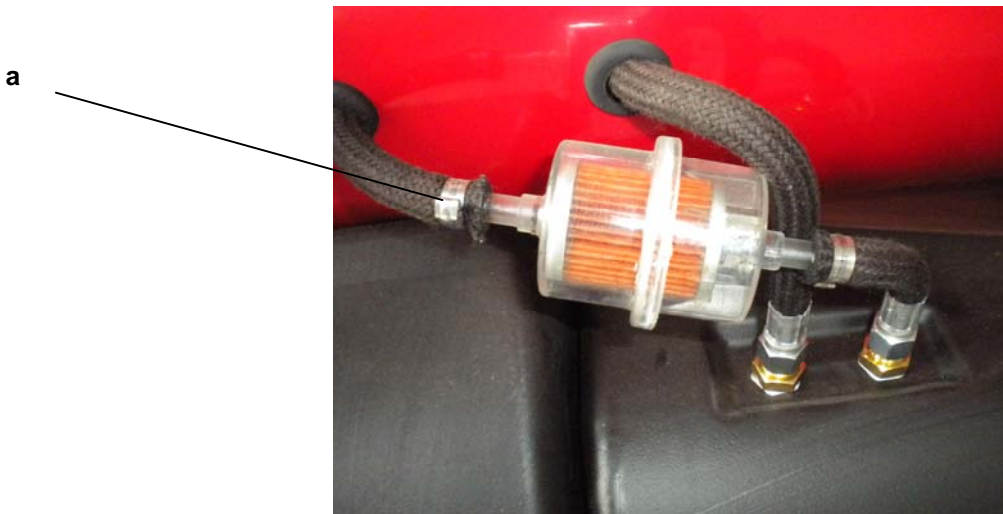

ii) Replace fuel filter

iii) Reassemble the filter assembly checking clips (a) are tightened

3) FUEL PUMP ASSEMBLY

a) To replace fuel pump, carry out the following procedure.

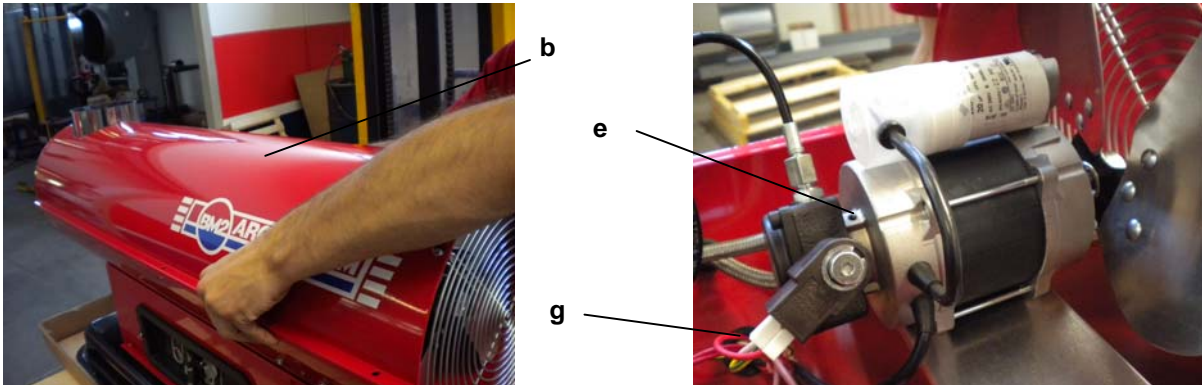

- i) Remove the top cover access panel (b) by removing six screws
- ii) Loosen three screws (e) on the fuel pump casing (be sure not to remove the screws)
- iii) Remove fuel pump from electric motor and keep plastic coupling for next reassembling
- iv) Disconnect wires lead to fuel solenoid valve (g)
- v) Reassemble new fuel pump on electric motor being sure that plastic coupling is aligned
- vi) Tighten three screws (e)
- vii) Reinstall the top cover.

b) To set fuel pressure on fuel pump, carry out the following procedure.

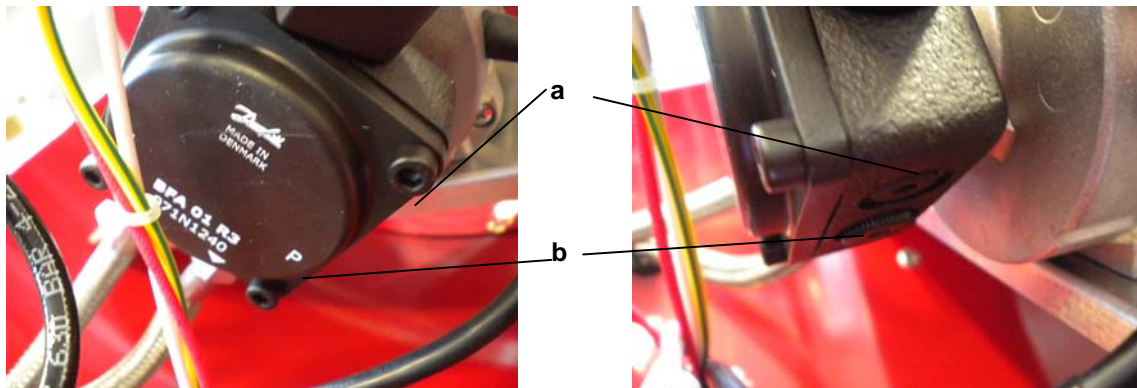

- i) Remove the top cover access panel (b) by removing six screws
- ii) Loosen cap (a) on side of fuel pump and connect a fuel pressure meter
- iii) Disconnect wires lead to fuel solenoid valve (to avoid fuel spray inside combustion chamber)



WARNING

The following operation shall be done with top cover and possible access to rotating fan.

Fan rotating area is covered by fan support even if accessible

Take measure to avoid touching any rotating parts while setting fuel pressure

- iv) Start the heater and check the fuel pressure be the value listed in the final technical sheet
- v) Correct the pressure by screwing (to increase pressure) or unscrewing (to decrease pressure) screw (b)



- vi) Remove fuel pressure meter and tighten cap (a)
- vii) Connect wires to solenoid fuel valve
- viii) Reinstall the top cover.

c) To clean the fuel filter on fuel pump, carry out the following procedure.

- i) Remove the cap (a) and extract the filter (b):

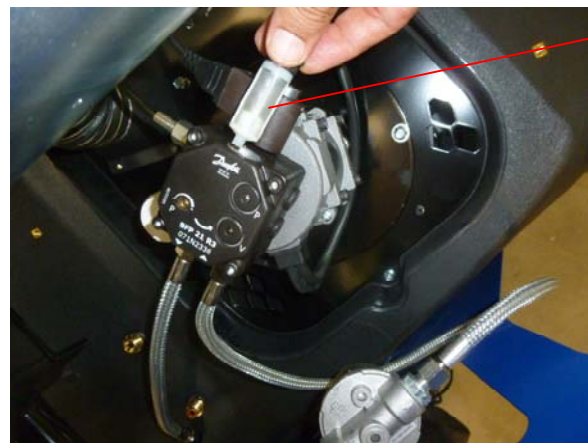

- ii) Clean the cell with clean fuel and reinstall it.

4) ELECTRIC PANEL ASSEMBLY

- a) To check electric control board, carry out the following procedure.
 - i) Remove two screws (a) on front/side of heater
 - ii) Remove top cover (b) of electric board (not for EC 100PT)



- iii) Check that all connections are complete and tight

- b) To check fuse on flame control box, carry out the following procedure.
 - i) Loosen ¼ clockwise the screw (c) , extract the fuse and check its integrity



- ii) If necessary, replace it with a new one
- iii) Reassemble top cover (b) (for EC 100PT only) and fix electric board to the heater

5) AIR PRESSURE SWITCH

- a) To check / replace air pressure switch on EC 100, carry out the following procedure.
i) Remove four screws (a) on side of heater

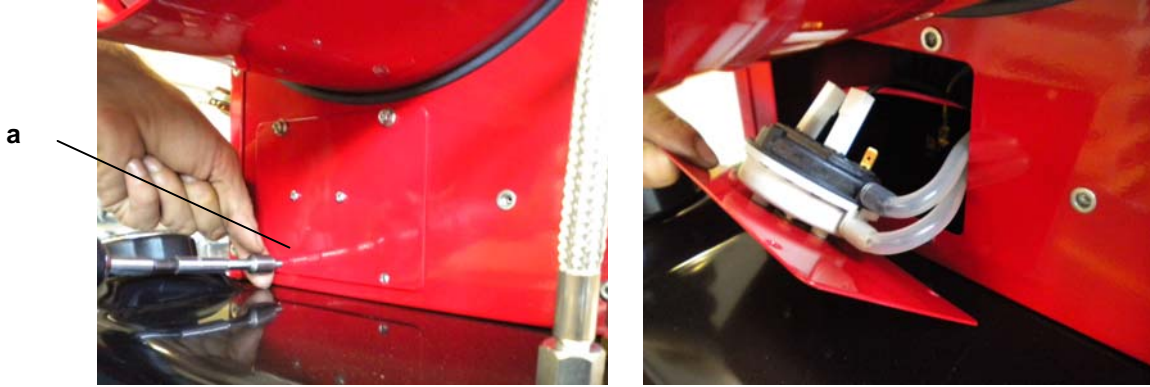

- ii) Pull air pressure switch assembly out of the base
iii) Check silicon tube are not pinched and tightened to connectors
iv) Check there is no debris inside silicon tube
v) Reassemble pressure switch assembly and tighten screws (a)
- b) To check / replace air pressure switch on EC 100PT, carry out the following procedure.
i) Open electric board panel as by step (4)
ii) Check air pressure switch inside electric board:
(1) Check silicon tube are not pinched and tightened to connectors
(2) Check there is no debris inside silicon tube



- iii) Reassemble electric board

6) COMBUSTION HEAD ASSEMBLY

- a) To clean combustion head assembly, carry out the following procedure.
 - i) Remove the top cover access panel (b) by removing six screws

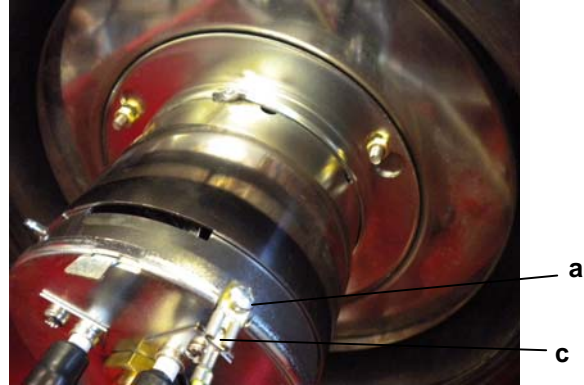

- ii) Loosen screw (a) and remove fast-on connector of yellow/green wire (c)
- iii) Turn counterclockwise burner support (d) and pull it out of burner tube (e)

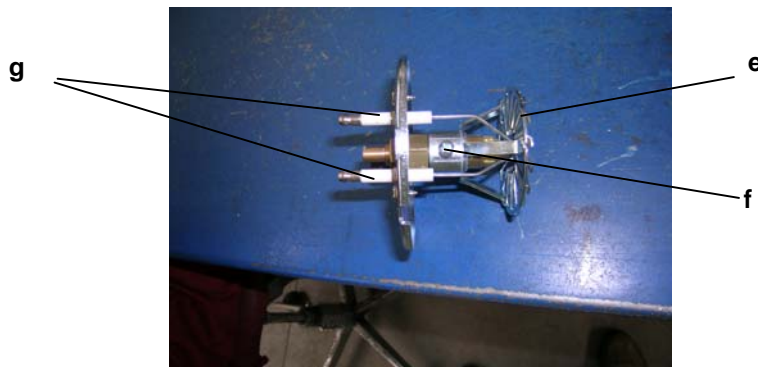
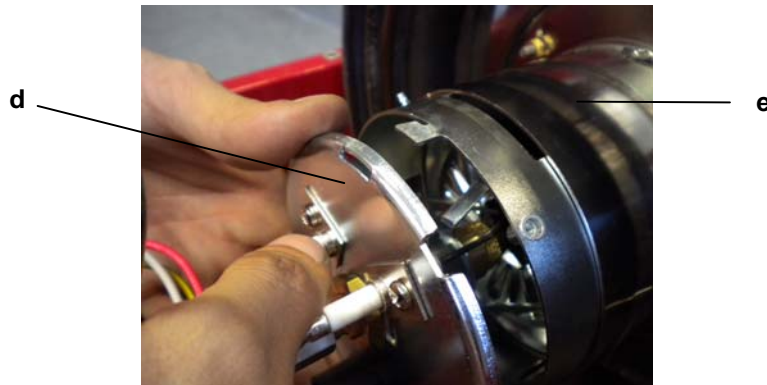

- iv) Check / Clean diffuser ring (f)
 - (1) be sure any debris or soot is eliminated every wing and opening on front surface of ring
 - (2) if necessary loosen screw (f) and remove it to wash using clean diesel
 - (3) check for any damage or bended part: if any replace it
- v) Check / clean ignition electrodes (g)
 - (1) Clean and remove any debris or soot on sharp ends of electrodes
 - (2) If necessary remove both electrodes and replace
 - (3) Check alignment as by following image: electrodes shall be centered and symmetric

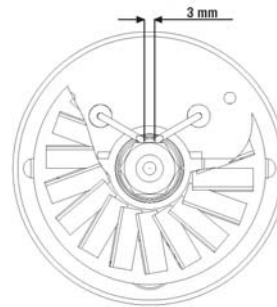

(4) Check electrode connectors (h) be tightened and clean

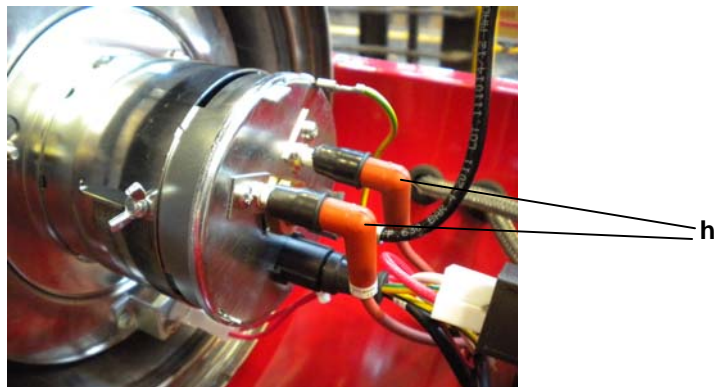

- vi) Check/replace fuel nozzle
 - (1) Refer to technical data sheet for specific indication of nozzle type
 - (2) Remove electrodes (g)
 - (3) Remove diffuser ring (f)
 - (4) Loosen fuel nozzle and place a new one
 - (5) Reassemble diffuser ring and electrodes taking care of each correct positioning as by previous instructions
- vii) Check / clean photocell
 - (1) Remove photocell (i) and check it is clean
 - (2) Check photocell support be clean and clean hole (m)

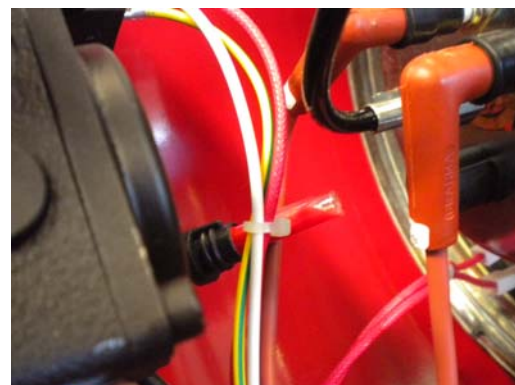
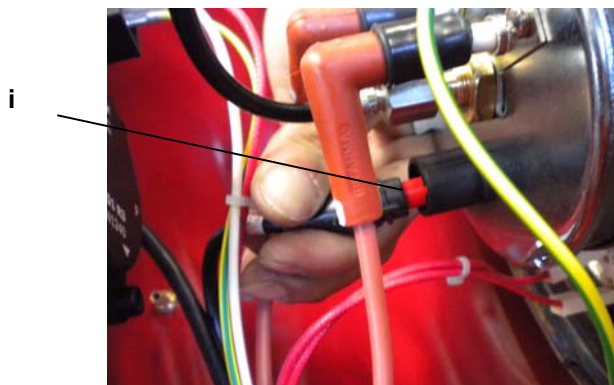

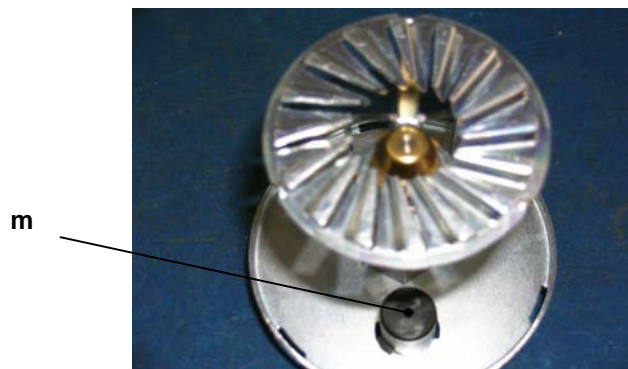

viii) Check / adjust air openings

- (1) Loosen nut (n)
- (2) Adjust lever (p) until the requested opening is obtained (check final tech. sheet)

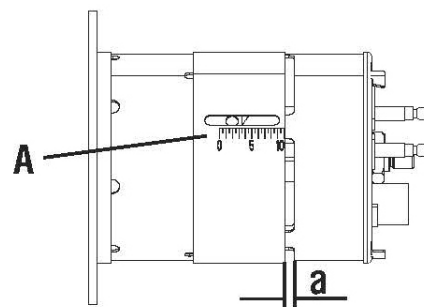
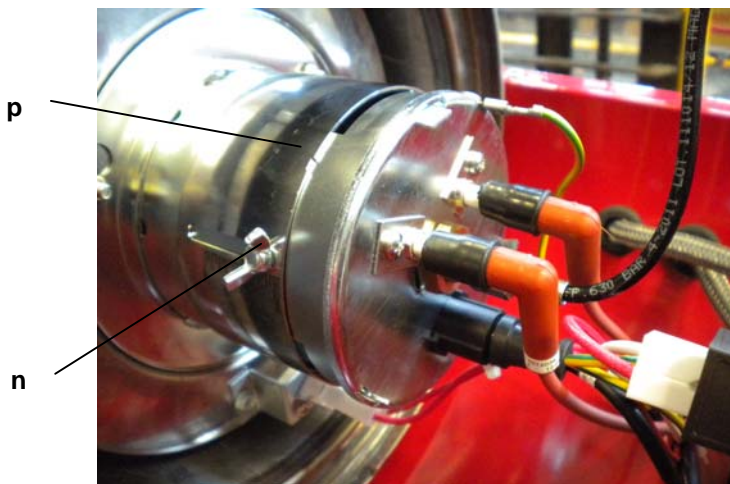

- ix) Reassemble combustion head
- x) Reassemble top cover

7) COMBUSTION CHAMBER ASSEMBLY

- a) To clean combustion chamber assembly, carry out the following procedure.
i) Remove the top cover access panel (b) by removing six screws

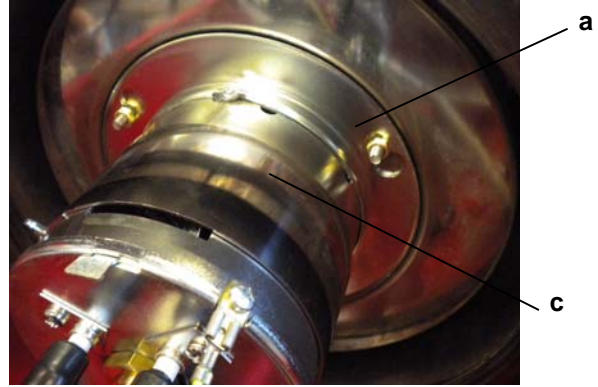

- ii) Loosen and remove three nuts (a)
iii) Remove the burner head tube assembly (c)
iv) Check and clean inside combustion chamber with a cloth, removing liquid fuel residual
v) Reassemble burner head tube assembly (c)
vi) Reassemble top cover (b)

8) COMBUSTION TEST (HEATER WITH FLUE ONLY)

- a) To check combustion smoke index with Shell-Bacharach method, carry out the following procedure.
i) Use a standard Bacharach pump (a).
ii) Insert a test strip (b) into the pump slot.
iii) Insert the pump end into the flue connection (c) or flue extension.

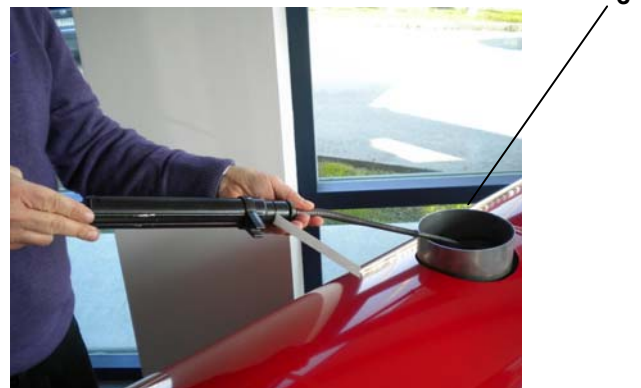
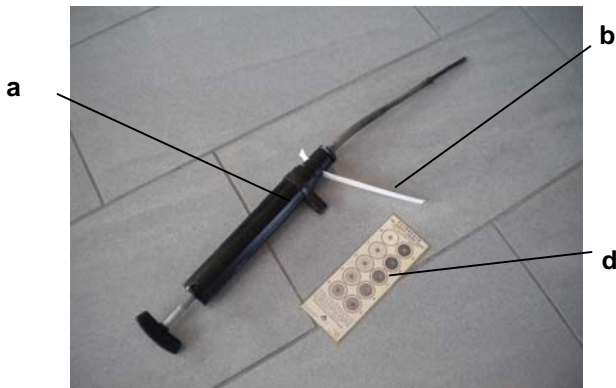

- iv) Start the heater and wait five minutes until it operates in standard conditions
v) Pump in exhaust gases for 10 times, taking care to carry out all movements slowly and using the complete piston stroke.
vi) Extract the paper strip, check the colour and compare it with the reference scale (d) to assign a smoke number:
(1) Oil-fired heaters are tested and set by factory to give a smoke number equal to 0 (zero) of the Shell-Bacharach scale.
(2) A smoke number greater than 1 indicates bad combustion. Refer to following troubleshooting guide to find the causes of the problem and to correct them.

6. WIRING DIAGRAM

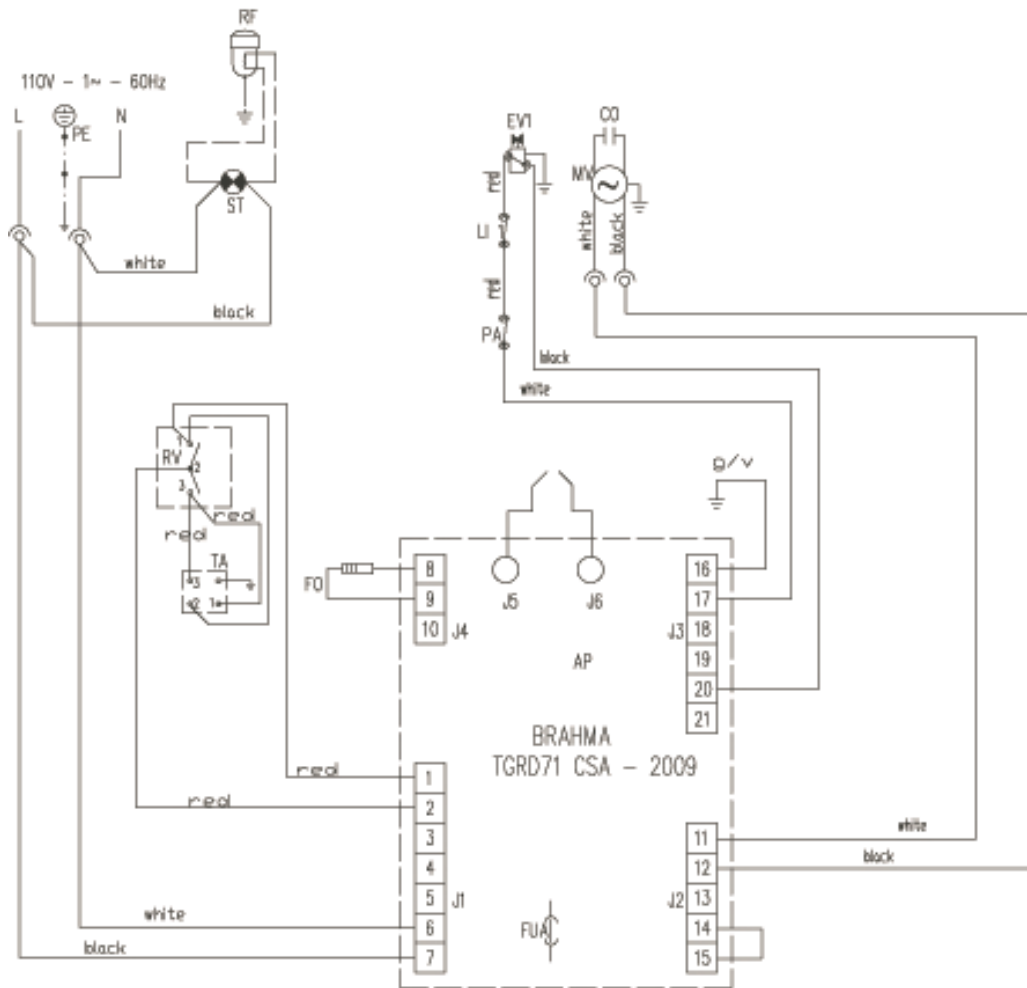

IT	H.T. Transformer	RV	Main switch
LI1	Overheat thermostat	TA	Room thermostat plug
EV1	Fuel solenoid valve	AP	Flame control box
FO	Photocell	RF	Heated fuel filter (optional)
CO	Capacitor	PA	Air pressure switch
MV	Fan motor	FUA	Fuse 6,3 A
ST	Control lamp		

NOTE

Air pressure switch PA and overheating thermostat LI1 are connected in serie to fuel valve EV1. Therefore in case PA and LI1 opens, the fuel valve EV1 is switched off and the flame control unit goes in lock-out in the "flame failure mode".

7. TECHNICAL SPECIFICATION

TECHNICAL SPECIFICATIONS		EC 100	
Heat input	[kBTU/h]	112.141	
Air flow	[cfm]	1,020	
Heat output	[kBTU/h]	94.759	
Fuel consumption	[USgal/h]	0.81	
	[lb/h]	5.733	
Power supply	Phase	1	
	Voltage	[V]	120
	Frequency	[Hz]	60
Electric consumption	[W]	440	
	[A]	4.05	
Nozzle	[USgal/h]	Delavan 0.55 - 80° W	
Pump pressure	[psi]	196	
Adjustment of combustion air flap	[in]	a=0.118	
	[°N]	A = -	
Static pressure	[in WC]	0.5	
Flue diameter	[in]	5.9	
Compulsory flue draft	[in WC]	0.05	

