



GERMICIDAL ULTRAVIOLET ROOM AIR SANITIZERS

Models RS72, RS140, RS435 & RSA760



Installation, Operation & Maintenance

Read and Follow All Safety Instructions. Save These Instructions.



**Germicidal Ultraviolet Equipment & Lamps
Manufacturers / Engineers / Sales / Service**

375 Marcus Boulevard, Hauppauge, NY 11788
(631) 273-0500 • Fax: (631) 273-0771
Email: Sales@AtlanticUV.com

Shop Products at
AtlanticUltraviolet.com

Learn More at **Ultraviolet.com**

Document No. 98-1181E5 • August 2025 • ©2025 Atlantic Ultraviolet Corporation®



Owner's Manual

TABLE OF CONTENTS

SAFETY WARNINGS	3
SAFETY INSTRUCTIONS	3
SAFETY LABELING	3
CAUTION	3
PRODUCT APPLICATION	4
CONSTRUCTION	4
PRINCIPLE OF OPERATION	4
LIMITATION OF USE.....	5
UNPACKING	5
INSTALLATION	5
FIXTURE PLACEMENT	5
REQUIRED TOOLS	5
DIMENSIONAL DATA.....	6
SET-UP INSTRUCTIONS.....	6-8
<i>STANDARD</i>	6-7
<i>STANDARD WALL MOUNTING</i>	7-8
MAINTENANCE	9
REQUIRED SUPPLIES.....	9
UNIT AND LAMP INSTALLATION, REPLACEMENT, OR CLEANING	9
INTAKE FILTER	10
CLEANING OF ELECTROSTATIC FILTER.....	10
BREAKAGE.....	10
DISPOSAL OF MERCURY ADDED LAMPS.....	10
OPTIONAL ACCESSORIES	10-11
TROUBLESHOOTING	11
TECHNICAL SPECIFICATIONS	12
REPLACEMENT PARTS	12-13
MAINTENANCE NOTES	14-15
USER ASSISTANCE	16
PATENT NOTICE.....	16
WARRANTY & PRODUCT REGISTRATION	16

These instructions generally describe the installation, operation and maintenance of the **SANITAIRE**[®] Germicidal Ultraviolet Room Air Sanitizers. Questions that are not specifically answerable by these instructions should be directed to the factory. Atlantic Ultraviolet Corporation[®] takes all possible precautions when packaging equipment to prevent damage. Carefully inspect and report all damages. Do not install damaged equipment. Follow all instructions on any labels or tags. Carefully inspect all packing materials before discarding to prevent the loss of accessories, mounting hardware, spare parts or instructions.

The information and recommendations contained in this publication are based upon data collected by the Atlantic Ultraviolet Corporation[®] and are believed to be correct. However, no guarantee or warranty of any kind, expressed or implied, is made with respect to the information contained herein. Specifications and information are subject to change without notice.



SAFETY WARNINGS

- All personnel should be alerted to the potential hazards indicated by the product safety labeling on this unit.
- The following conventions are used to indicate and classify precautions in this manual and on product safety labeling. Failure to observe precautions could result in injury to people or damage to property.

 This is the safety alert symbol. It is used to alert you to potential personal injury hazards. Obey all safety messages that follow this symbol to avoid possible injury or death.

⚠ DANGER Danger indicates an **IMMINENTLY** hazardous situation, which, if not avoided, **WILL** result in death or serious injury.

⚠ WARNING Warning indicates a **POTENTIALLY** hazardous situation, which, if not avoided, **COULD** result in death or serious injury.

⚠ CAUTION Caution indicates a **POTENTIALLY** hazardous situation, which, if not avoided, **MAY** result in minor or moderate injury.

CAUTION Caution used without the safety alert symbol indicates a potentially hazardous situation, which, if not avoided, may result in property damage.

 This symbol is used to identify an **ELECTRICAL SHOCK** or **ELECTROCUTION** hazard.

 This symbol is used to identify an **ULTRAVIOLET LIGHT** hazard.

 This symbol is used to identify the need to wear approved ultraviolet blocking eye wear.

 This symbol is used to identify the need to wear approved ultraviolet blocking face shield.



 This symbol is used to identify the need to wear protective gloves.



 This symbol is used to identify components which must not be disposed of in trash

SAFETY INSTRUCTIONS

⚠ WARNING To guard against injury, basic safety precautions should be observed, including the following:

1. Read and follow **ALL** safety instructions.

   **⚠ CAUTION** Avoid exposure to direct or reflected germicidal ultraviolet rays. Germicidal ultraviolet rays are harmful to the eyes and skin.

2. Intended for indoor use only.
3. Do not alter design or construction.
4. Do not use this fixture for other than its intended purpose, as described in this manual.
5. **⚠ CAUTION** Do not override safety interlock.
6. Do not mount under any source of moisture or condensation, such as humidifiers, cooling coils, etc.
7. Do not remove any labels or devices.
8.  **⚠ WARNING** Do not operate without proper electrical ground.
9. Do not operate the unit if there is visible or suspected damage to the unit or, if applicable, there is damage to power cord and/or plug.
10. Keep inlet and outlet, of the blowers, clean and clear of debris.
11. **⚠ CAUTION** Do not operate without access cover secured.
12. Stay clear of blowers, or other moving parts that can cause injuries.
13. Utility power supplied, to the unit, **MUST** match power requirements listed on the unit label.
14.  **⚠ DANGER** Always disconnect power to the unit before performing any service or maintenance.
15. Read and follow all notices and warnings on the unit.
16. **SAVE THESE INSTRUCTIONS.**

SAFETY LABELS

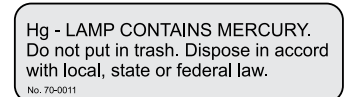
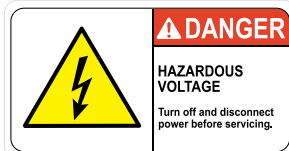
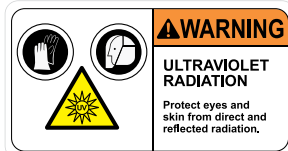

Warning: Ultraviolet Radiation (70-0052A) Danger: Hazardous Voltage (70-0053) Warning Germicidal UV (70-0037) Hg - Lamp Contains Mercury (70-0011)

CAUTION

It is the user's responsibility to determine and validate the suitability of this equipment for use in the user's system or process. No warranty or representation is made by the manufacturer with respect to suitability or performance of this equipment or to the results that may be expected from its use. The user should periodically inspect, clean as necessary and confirm the presence and good legibility of the product safety labels. Contact the factory for replacement labels in the event that any of the labels are missing or illegible.

PRODUCT APPLICATION

CONSTRUCTION

The **SANITAIRE**® Germicidal Ultraviolet Room Air Sanitizer consists of:

- **STER-L-RAY**® Germicidal Ultraviolet Lamp(s), which deliver germicidal ultraviolet energy at the specific wavelength of 254 nanometers (nm), which effectively destroys airborne microbes including: virus, bacteria, and mold spores.
- **Surelite**™ Electronic Ballast(s) capable of operating at 120v 50/60 Hz or 230v 50/60 Hz. Other power supplies may be available. Contact factory for specifics.
- A polished reflector, whose design and specular aluminum construction maximizes ultraviolet intensity within the exposure chamber
- A standard, NEMA 5-15, three-prong plug, and operates on 120VAC 60Hz single-phase standard household current. The **SANITAIRE**® is also available for operation on 230VAC 50Hz.
- **Promate**™ permanent, washable, electrostatic intake filter(s), capable of removing airborne particles as small as 5 microns.
- A louvered exhaust, which restricts ultraviolet radiation from passing into the room, protecting the room's occupants from ultraviolet exposure.
- A **Promate**™ Sight Glass Assembly, which provides a safe visual indication of germicidal lamp(s) operation without the risk of ultraviolet exposure.
- An enclosure and access cover constructed of stainless steel, type 304. Stainless steel construction provides strength, durability, and lasting value.
- An interlock safety switch. The interlock switch interrupts power to the sanitizer, when the access cover is removed from the lamp/exposure chamber.
- Molded rubber feet, for use on tabletops, shelves, etc. and standard wall mounting brackets (Models RS72, RS140 and RS435 only). These brackets allow the **SANITAIRE**® to be mounted to a wall, or other vertical surface, in either the vertical or horizontal position. Optional mounting kits are available; consult our UV Application Specialists for specific details.
- A .3-micron, 99.97% minimum efficiency, HEPA type, absolute filter (Model RSA760 only).

PRINCIPLE OF OPERATION

The **SANITAIRE**® design has been carefully conceived to provide germicidal ultraviolet exposure for air disinfection. The dosage, as it applies to ultraviolet disinfection, is a function of time, and the intensity, of ultraviolet radiation, to which the air is exposed. The exposure time, in seconds, is the total time it takes the air to move through the ultraviolet field, produced by the germicidal lamp(s). Exposure time is related to the airflow rate; the higher the airflow, the lower the exposure time or the lower the airflow, the higher the exposure time. The operation of the **SANITAIRE**® Germicidal Ultraviolet Room Air Sanitizer is as follows:

1. Air is drawn into the fixture through the electrostatic filter(s).
2. The air is forced into the exposure chamber, where it is irradiated by the germicidal ultraviolet lamp(s).
3. Sight glass provides a safe visual indication of germicidal lamp operation.
4. The purified air exits the fixture, through the louvered exhaust panel, located at the opposite end of the fixture. In the case of the **SANITAIRE**® Model RSA760, once through the louvered exhaust panel, air is forced through a .3 micron HEPA filter and finally through an electrostatic particulate filter before exiting the fixture.

Figure 1 – **SANITAIRE**® Germicidal UV Room Air Sanitizer Operation (RS435 Shown)

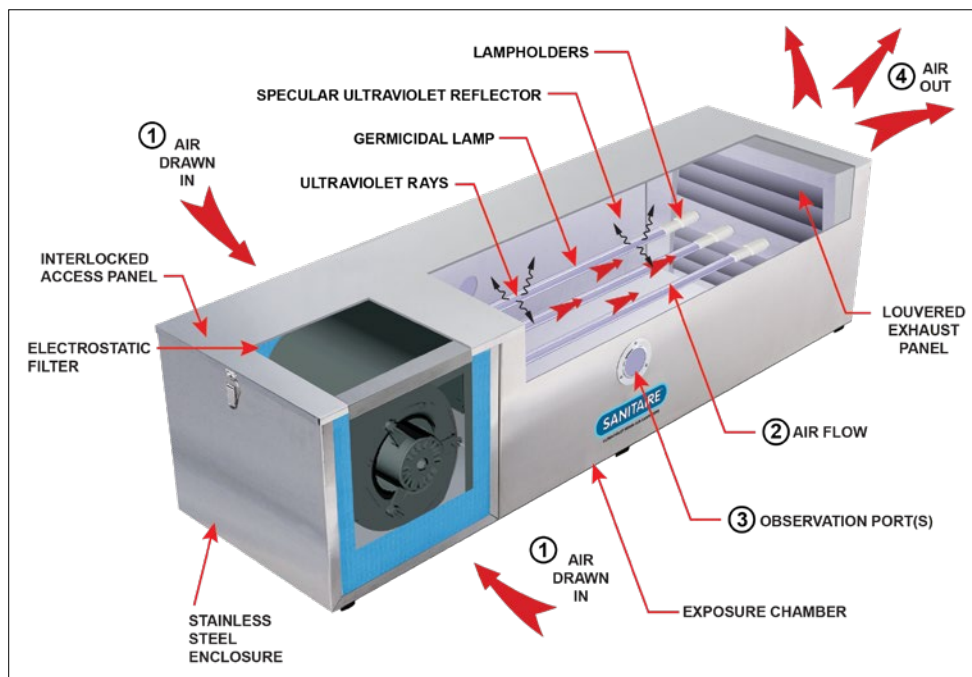

LIMITATION OF USE

- Overexposure to germicidal ultraviolet rays will result in the irritation of the eyes and reddening of the skin. For that reason, it is of the utmost importance that your ultraviolet application be carefully planned and implemented so as to avoid exposure, of personnel, to direct or reflected ultraviolet rays.
- The American Conference of Governmental Industrial Hygienists (ACGIH) has established that the ultraviolet radiant exposure incident for unprotected eyes or skin should not exceed 0.2 microwatts per square centimeter ($\mu\text{W}/\text{cm}^2$) at 254 nanometers (nm) for an eight (8) hour period. (“2004 TLVs® and BEIs®”)

UNPACKING



IN ORDER TO PERFORM THIS TASK, BE SURE TO WEAR THE FOLLOWING SAFETY EQUIPMENT: SAFETY GLASSES OR A FACE SHIELD, AS WELL AS GLOVES.

- Remove the **SANITAIRE®** Germicidal Ultraviolet Room Air Sanitizer from its shipping carton.
- Atlantic Ultraviolet Corporation® takes all possible precautions when packaging this fixture to prevent damage. Carefully inspect the sanitizer, and (if applicable) the power cord and plug for damage. Report all damage immediately. Do not assemble or operate if there is any damage, visible or suspected.
- **STER-L-RAY®** Germicidal lamp(s) are packed separately, to ensure maximum protection for the lamps. Keep the lamp(s) aside until ready for installation.
- Carefully inspect all packing materials to prevent the loss of accessories, mounting hardware, spare parts or instructions.
- Do not discard packing materials until fixture is assembled and check out is complete.

The **SANITAIRE®** Model RS72 includes:

- 1 - 72 CFM displacement/1-lamp unit with 5-foot line cord (approximate)
- 1 - **STER-L-RAY®** Germicidal Ultraviolet Lamp
- 1 - Standard **Promate™** Wall Mounting Kit
- 1 - Operating Instructions

SANITAIRE® Model RS435 includes:

- 1 - 435 CFM displacement/4-lamp unit with 5-foot line cord (approximate)
- 4 - **STER-L-RAY®** Germicidal Ultraviolet Lamps
- 1 - Standard **Promate™** Wall Mounting Kit
- 1 - Operating Instructions

SANITAIRE® Model RS140 includes:

- 1 - 140 CFM displacement/2-lamp unit with 5-foot line cord (approximate)
- 2 - **STER-L-RAY®** Germicidal Ultraviolet Lamps
- 1 - Standard **Promate™** Wall Mounting Kit
- 1 - Operating Instructions

SANITAIRE® Model RSA760 includes:

- 1 - 760 CFM displacement/4-lamp unit with 5-foot line cord (approximate)
- 1 - HEPA/Particulate Absolute Filter Assembly
- 4 - **STER-L-RAY®** Germicidal Ultraviolet Lamps
- 1 - Standard **Promate™** Wall Mounting Kit
- 1 - Operating Instructions

INSTALLATION

FIXTURE PLACEMENT

For maximum efficiency the **SANITAIRE®** should be located as centrally as possible, preferably not close to the floor or the corners of the area to be treated. Access to the room does not need to be controlled while the fixture is operating. The louvered exhaust panel, of the **SANITAIRE®** Germicidal Ultraviolet Room Air Sanitizer, restricts ultraviolet radiation from passing into the room, protecting the room's occupants from ultraviolet exposure.

To ensure safe and proper use, make sure the area:

- Has a properly-grounded electrical outlet within approximately 5 feet of the unit.
- Has a plumb, secure wall, for standard wall mounting.

⚠ DANGER Failure to adequately support this equipment could result in serious injury or even death.

REQUIRED TOOLS

- Pencil
- Tape measure
- Spirit level
- Power drill with drill bits and drivers
- If wall mounting, support hardware appropriate for the wall construction
- Soft, clean, lint-free cloth
- Denatured alcohol

DIMENSIONAL DATA

Figure 2 – Dimensional Data

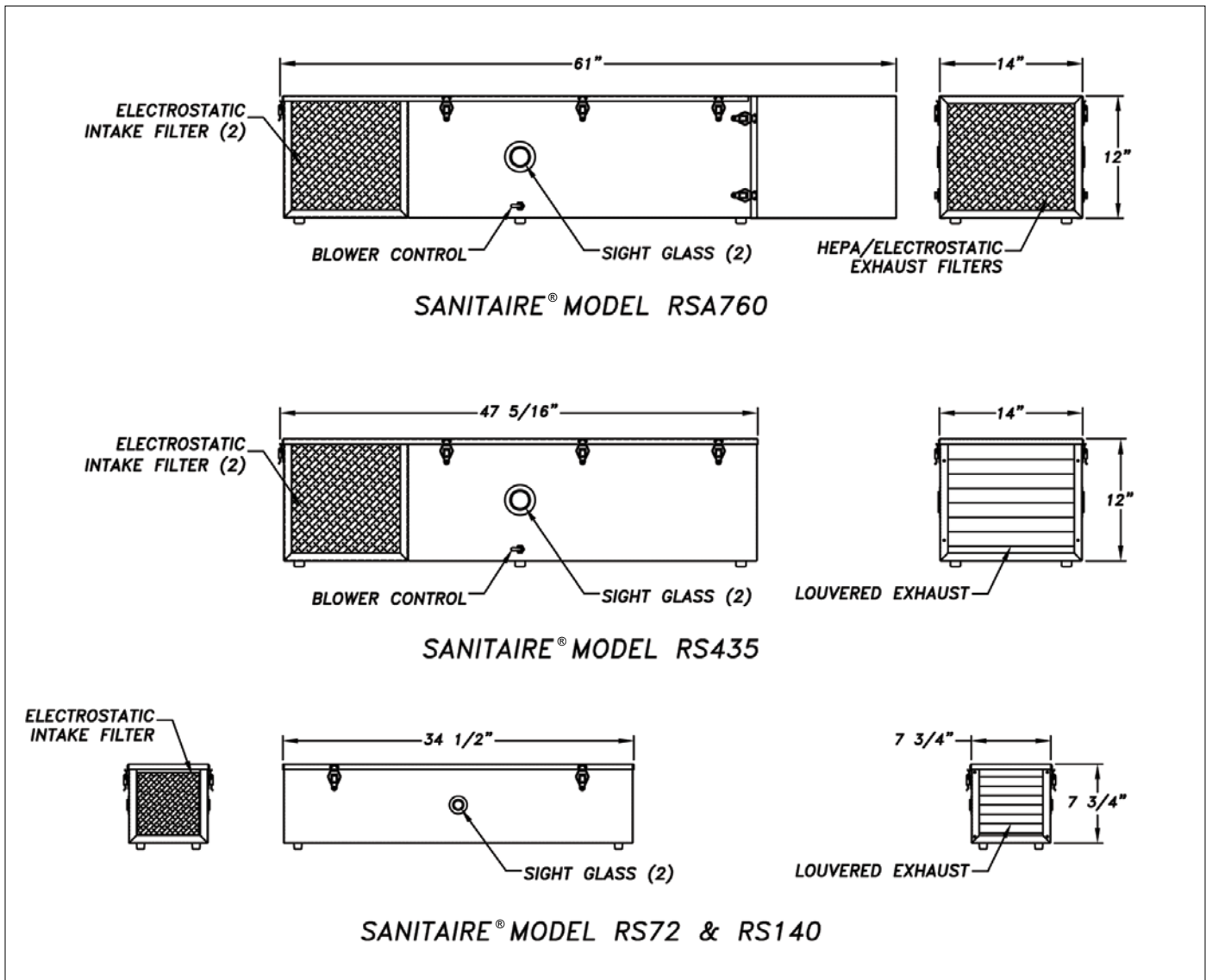

All specifications, dimensional data, etc. are approximate and subject to change without notice.

SETUP INSTRUCTIONS



IN ORDER TO PERFORM THIS TASK, BE SURE TO WEAR THE FOLLOWING SAFETY EQUIPMENT: SAFETY GLASSES OR A FACE SHIELD, AS WELL AS GLOVES.

⚠ DANGER Always disconnect power to the fixture before performing any service or maintenance.

STANDARD

The **SANITAIRE®** Germicidal Ultraviolet Room Air Sanitizers are portable, and require no professional installation.

1. Place fixture in selected location.
2. Unlatch and remove access cover. Remove the film on the specular ultraviolet reflector in the exposure chamber, and inside the interlock access panel cover.
3. Install **STER-L-RAY®** lamp(s) following the steps in “Unit and Lamp Installation, Replacement, or Cleaning” in the “Maintenance” section.
4. Replace and re-latch access cover.



Watch our instructional videos for a step-by-step guide to Sanitaire® installation, lamp replacement, and maintenance.

5. On **SANITAIRE**® Model RSA760, the HEPA/particulate exhaust filter assembly is packed separately and must be installed onto the main fixture. To install: line up the latches on the unit with the catches on the filter housing and draw tight.
6. Plug power cord into the electrical outlet.
7. Verify operation by safely viewing lamps through sight glass. If the **SANITAIRE**® is not operating properly, go to the “**Troubleshooting**” section.



CAUTION Avoid exposure to direct or reflected germicidal ultraviolet rays.
Germicidal ultraviolet rays are harmful to the eyes and skin.

STANDARD WALL MOUNTING

DANGER Failure to adequately support this equipment could result in serious injury or even death.

The **SANITAIRE**® Germicidal Ultraviolet Room Air Sanitizer, Models RS72, RS140, and RS435 include a set of standard wall mounting brackets. The brackets allow the **SANITAIRE**® to be mounted to a wall, or other vertical surface, in either the vertical or horizontal position. Once installed onto the fixture, the wall mounting brackets provide four (4) 5/16” mounting holes, on Models RS72, and RS140, or six (6) 5/16” mounting holes on the Model RS435.

Figure 3 – Typical Mounting Using Standard Wall Mounting Brackets

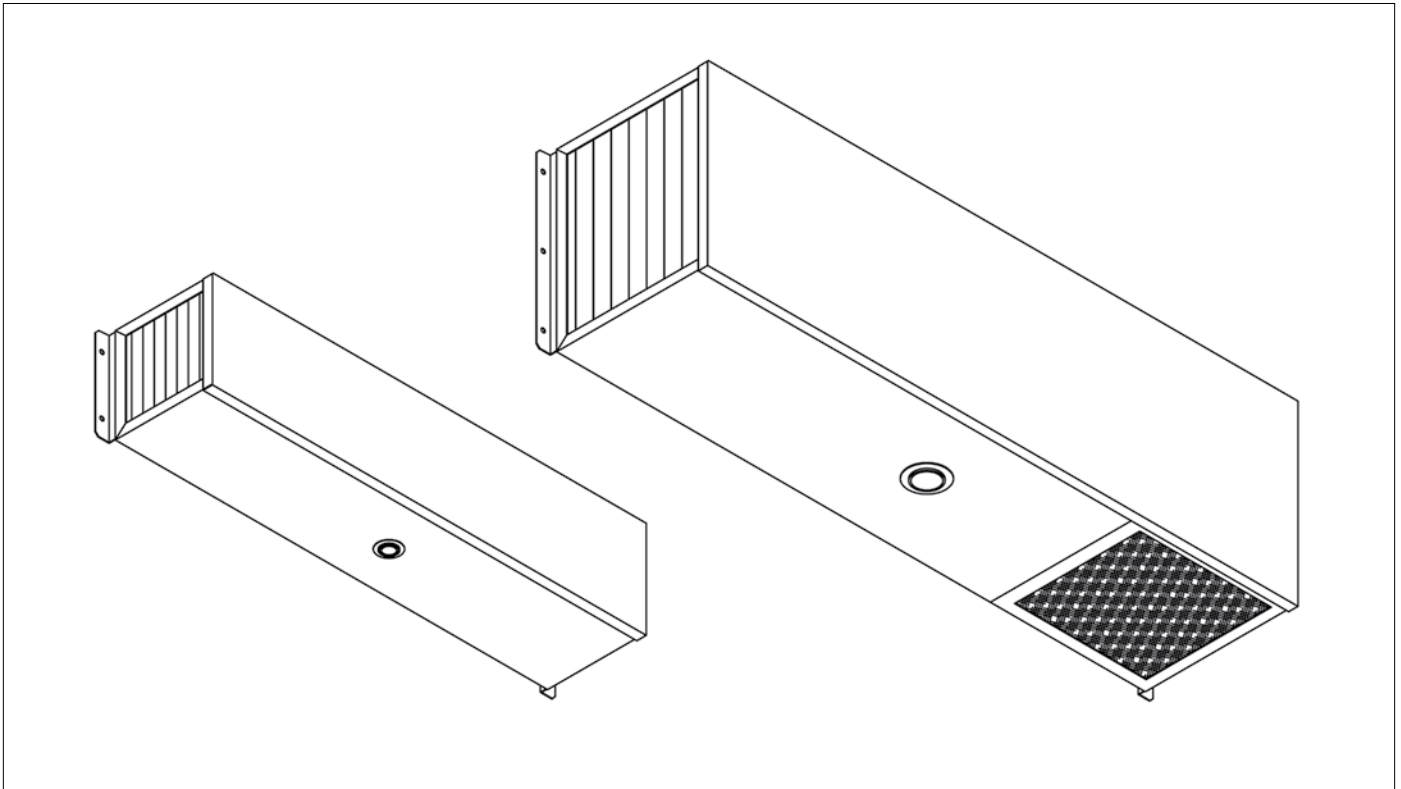

⚠ CAUTION Proper installation is important. Special fasteners are required. If in doubt, installation should be done by a qualified professional.

1. Select a plumb, secure wall which is capable of supporting the weight of the **SANITAIRE®**, with a properly grounded, electrical outlet within approximately 5 feet of the desired placement area. **NOTE:** Utility power supplied, to the unit, **MUST** match power requirements listed on the fixture label.
2. Locate and mark the centers of mounting holes in accordance with the appropriate Figure.

Figure 4 – RS72 & RS140 Bolt Hole Location

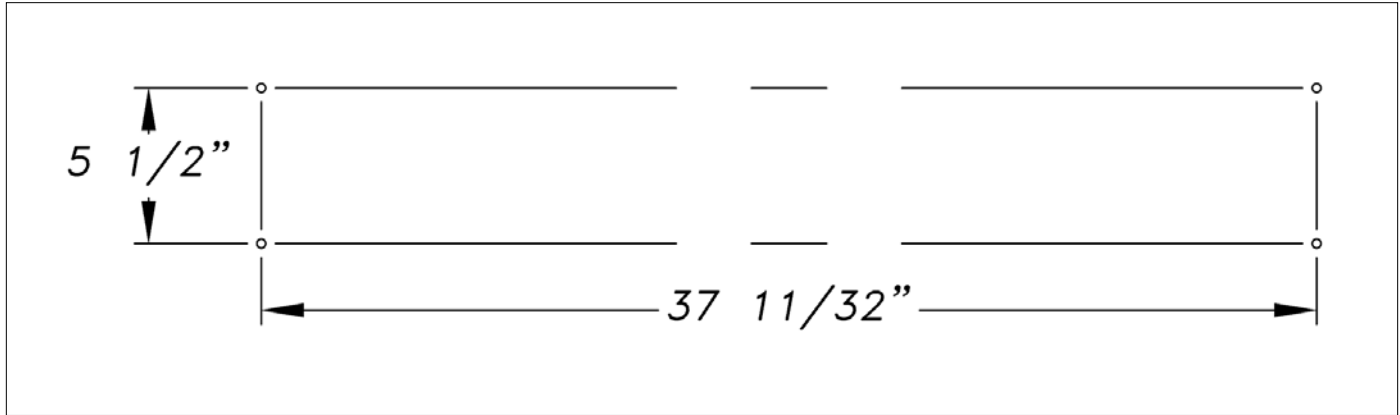
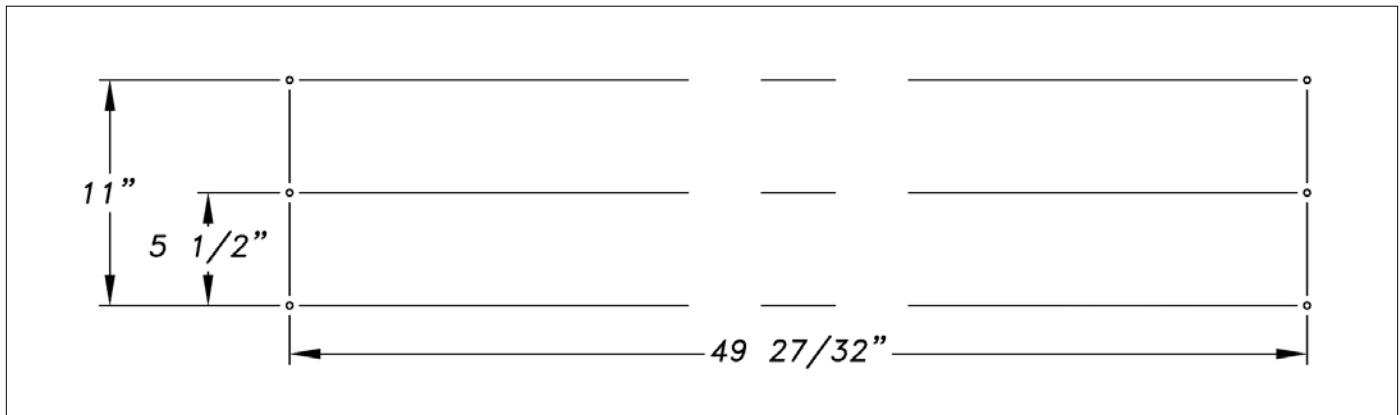

Figure 5 - RS435 Bolt Hole Location



3. Following manufacturer's instructions, prepare wall for mounting hardware installation.
4. Locate and remove the molded rubber feet and 1/4"-20 x 3/4" long screws. Attach wall-mounting brackets re-using the 1/4"-20 x 3/4" long screws.

⚠ CAUTION Assistance is required when attempting to wall mount **SANITAIRE®** Germicidal Ultraviolet Room Air Sanitizers; they are bulky and better handled by 2 people.

5. Lift **SANITAIRE®** into position; align bracket-mounting holes. Insert mounting hardware into each of the mounting holes.
6. **Avoid** over tightening! Over tightening may damage or weaken the mounting surface or the mounting hardware.
7. Install **STER-L-RAY®** lamp(s) following the steps in "Unit and Lamp Installation, Replacement, or Cleaning" in the "Maintenance" section.

MAINTENANCE

 **⚠ DANGER** Always disconnect power to the fixture before performing any service or maintenance.

- The **SANITAIRE**[®] is designed to operate with a minimal amount of maintenance.
- A regular cleaning cycle of the **STER-L-RAY**[®] Germicidal Lamp(s), interior, sight glass and intake filter(s) **MUST** be established, and carefully maintained, based on inspection and experience. The frequency of cleaning will vary with the conditions surrounding each installation. It is recommended that the ultraviolet lamp(s) be cleaned at least once every three (3) months.
- The **STER-L-RAY**[®] Germicidal Ultraviolet Lamp(s) used in the **SANITAIRE**[®] have a manufacturer's rated average effective life of 10,000 hours. Lamps may operate longer than their rated effective life, but the reduction in ultraviolet output will make it impractical to use past the manufacturer's rated life. For maximum efficiency lamp replacement is recommended every 10,000 hours of operation or about one (1) year of continuous use.
- Unless lamp replacement is due to failure or breakage, it is recommended that all lamps be replaced at the same time.

 **⚠ CAUTION** Do not override the safety interlock switch. Operation of the fixture with the interlock switch overridden and the Access Door open will expose personnel to direct or strongly reflected germicidal ultraviolet rays. Germicidal ultraviolet rays are harmful to the eyes and skin.

REQUIRED SUPPLIES

- Vacuum cleaner
- Detergent
- Water
- Soft, clean, lint-free cloth
- Denatured alcohol

UNIT AND LAMP INSTALLATION, REPLACEMENT, OR CLEANING



IN ORDER TO PERFORM THIS TASK, BE SURE TO WEAR THE FOLLOWING SAFETY EQUIPMENT: SAFETY GLASSES OR A FACE SHIELD, AS WELL AS GLOVES.

 **⚠ DANGER** Always disconnect power to the fixture before performing any service or maintenance.

⚠ CAUTION Ultraviolet lamp(s) are easily damaged and may cause injury if broken. Exercise care when handling.

1. Disconnect power to the fixture and unplug from the electrical outlet.
2. Remove **STER-L-RAY**[®] lamp(s), carefully press lamp against the spring-loaded lampholder, when upper lamp pin clears the stationary lampholder pull lamp out, and away from unit.
3. Moisten a clean, lint-free cloth with denatured alcohol and clean **STER-L-RAY**[®] lamp(s).
4. When **STER-L-RAY**[®] lamp(s) have been removed, cleaned and safely set aside, remove any loose dust or dirt from the interior of the unit with a soft dry cloth, or vacuum.
5. To remove any dust, dirt, fingerprints, smears, etc, from the outer surfaces of the **SANITAIRE**[®] Germicidal Ultraviolet Room Air Sanitizer, moisten a clean, lint-free cloth with denatured alcohol and wipe down the unit. Buff out any streaks left with a soft dry cloth.
6. Install **STER-L-RAY**[®] lamp(s), insert lamp pin into spring-loaded lampholder. Carefully press lamp against the spring-loaded lampholder. Align upper lamp pin with stationary lampholder. Slowly ease the pressure until lamp is fully seated in lampholders.
7. Verify that **STER-L-RAY**[®] lamps are properly seated.
8. Repeat until all **STER-L-RAY**[®] lamps have been properly reinstalled.
9. Restore power to the fixture.



Watch our instructional videos for a step-by-step guide to Sanitaire[®] installation, lamp replacement, and maintenance.



⚠ CAUTION Avoid exposure to direct or reflected germicidal ultraviolet rays. Germicidal ultraviolet rays are harmful to the eyes and skin.

10. Verify operation by viewing lamp(s), use of personal protection equipment is required. If the unit is not operating properly, go to “**Troubleshooting**” section.

INTAKE FILTER

- The **SANITAIRE**® Germicidal Ultraviolet Room Air Sanitizers are fitted with a permanent, washable, electrostatic air filter. **DO NOT** apply oil or adhesive sprays to the filter.
- In most applications, regular vacuuming will maintain peak performance of **Promate**™ Electrostatic Filter(s); periodically flushing electrostatic filter(s) with clean water is recommended whenever vacuuming fails to restore a clean appearance.
- **Promate**™ Electrostatic Filter(s) may be cleaned repeatedly without loss of efficiency. The frequency of cleaning will vary with the conditions surrounding each installation.
- The **Promate**™ Absolute HEPA Filter is not washable and must be replaced after one year of continuous operation.



Watch our instructional videos for a step-by-step guide to Sanitaire® installation, lamp replacement, and maintenance.

CLEANING OF ELECTROSTATIC FILTER



IN ORDER TO PERFORM THIS TASK, BE SURE TO WEAR THE FOLLOWING SAFETY EQUIPMENT: SAFETY GLASSES OR A FACE SHIELD, AS WELL AS GLOVES.

⚠ DANGER Always disconnect power to the fixture before performing any service or maintenance.

1. Disconnect power to the fixture.
2. Unlatch and remove access cover.
3. Remove **Promate**™ filter(s) from the housing, noting airflow direction. The label on the filter frame shows the direction of air flow through the filter
4. Vacuum the upstream side first, and repeat on the discharge side. (Skip to Step 7 unless washing filter.)

⚠ CAUTION Do not use a high velocity water stream to clean the filter. A high velocity stream may destroy the filter's internal fibers.

5. To wash **Promate**™ filter, flush thoroughly with clean water, either by immersing or with a fine spray in the direction opposite to the airflow. If the filter is contaminated with heavy grease concentrations, wash filter with a detergent solution.
NOTE: Follow all manufacturer's instructions and precautions for handling detergents. The filter should be rinsed thoroughly with clean water.
6. Shake off any excess water from filter and let dry.
7. Replace **Promate**™ filter into the housing, with airflow direction label pointing into the electrical enclosure.
8. Close and re-latch access cover.
9. Restore power to the fixture.
10. Verify operation by safely viewing lamp(s) through sight glass. If the fixture is not operating properly, go to the "Troubleshooting" section.

BREAKAGE

⚠ CAUTION Broken Quartz is SHARP.



Wear protective gloves when handling broken ultraviolet lamp(s). In the event of breakage, **DO NOT** use a household vacuum cleaner to pick up quartz fragments. Sweep up debris into a plastic bag and dispose of properly.

DISPOSAL OF MERCURY ADDED LAMPS



Germicidal ultraviolet lamps, like standard fluorescent lamps contain small amounts of mercury. Mercury added lamps should not be placed in the trash. Dispose of properly. For further information regarding the disposal and recycling of lamps containing mercury, along with Federal and State requirements visit LampRecycle.org. For more information on **STER-L-RAY**® Germicidal Ultraviolet Lamps, visit AtlanticUltraviolet.com or Ultraviolet.com.

OPTIONAL ACCESSORIES

1. **ArmorLite**™ Germicidal Ultraviolet Lamp Safety Shield: A protective coating applied to **STER-L-RAY**® lamps, and ensuring protection by eliminating the dangers associated with fragments of broken glass and mercury contamination.
2. **SENTINEL**™ Germicidal Ultraviolet Lamp Operation Indicator*: (Must be ordered at same time as **SANITAIRE**® fixture.) Monitors lamp operation of the ultraviolet fixture, and can be mounted using 25, 50 or 100 foot cables.

Continued on next page

OPTIONAL ACCESSORIES CONT.

3. **Promate™ Elapsed Time Indicator***: A non-resettable display of the operating hours. Useful for scheduling and recording maintenance and lamp replacement.
4. **Promate™ Integral Key Lock Switch***: Ensures tamperproof operation, in either the “ON” or “OFF” position.
5. **Promate™ Disposable Filters**: Cardboard frame filters, for use when frequent filter changes are necessary.
6. **Promate™ Ceiling Mount Kit (40-0001)**: Kit includes four (4) eyebolts to suspend sanitizer from the ceiling.
7. **Promate™ Wall Mounting Kit (40-1209)**: Designed to allow **SANITAIRE®** Models RS72 and RS140 to mount to a vertical wall in a horizontal position.
8. **Zenith™ Germicidal Ultraviolet Detector (30-1015)**: A sensitive, hand-held, self-contained battery operated ultraviolet meter that can be used for:
 - Monitoring UV-C Germicidal Lamp Intensity & Aging
 - Measuring UV-C Germicidal Fixture Leakage
9. **Promate™ Safety Glasses (00-1299)**: Safety eyewear **MUST** be used as general-purpose safety protection and for additional shielding from ultraviolet rays.
10. **Promate™ Face Shield (00-0126)**: Lightweight visor with adjustable headgear provides eye and face protection from germicidal ultraviolet rays.

*This accessory must be ordered at the time of initial equipment purchase. All other accessories can be ordered and installed at the time of initial equipment purchase and installation or added at a later date.

For more information and purchasing, contact our offices weekdays between 8:30 am and 5:00 pm Eastern time at: Atlantic Ultraviolet Corporation®, 375 Marcus Boulevard, Hauppauge, New York, 11788 • Tel: (631) 273-0500 • Fax: (631) 273-0771
Email: Sales@AtlanticUV.com • Shop: AtlanticUltraviolet.com • Learn More: Ultraviolet.com

TROUBLESHOOTING

 **⚠ DANGER** Always disconnect power to the fixture before performing any service or maintenance.



⚠ CAUTION Use personal protection equipment, such long sleeves with no gaps between cuffs and gloves, and ultraviolet resistant face shield, if troubleshooting **SANITAIRE®**.

IMPORTANT: This unit is to be serviced **ONLY** by qualified, and appropriately trained and/or licensed personnel.

Table 1 – Troubleshooting

Problem	Possible Cause	Corrective Action
SANITAIRE® unit not operating.	No electrical power.	Verify that the unit is connected to a live power source.
	Power connection to fixture is loose or disconnected.	Verify power connection to fixture is fully engaged.
Internal blower(s) not functioning.	Loose power connection.	Confirm connection to blower; connection is tight and makes full contact.
	Faulty blower motor.	Replace blower motor.
(1) STER-L-RAY® Germicidal Lamp not operating	Surelite™ Ballast not functioning.	Swap lamp, with known good lamp. If good lamp still does not operate, replace ballast.
	STER-L-RAY® Germicidal lamp not operating.	Swap suspect lamp, with known good lamp. If suspect lamp still does not operate, replace lamp.
	STER-L-RAY® Germicidal lamp not properly seated.	Confirm contact of lamp and lampholder is tight, and that lampholder is making full contact with lamp.
	Surelite™ Ballast not functioning.	Locate corresponding ballast and replace.
All STER-L-RAY® Germicidal Lamps not operating.	STER-L-RAY® Lamps not installed.	Install lamps.
	Interlock switch open.	Confirm access cover is on and latched.
	Interlock switch faulty.	Replace interlock switch.

If the above measures fail to correct the problem(s), contact our UV Application Specialists. Contact options can be found in the “User Assistance” section.

TECHNICAL SPECIFICATIONS

Table 2 – Technical Specifications

Model Numbers		RS72	RS140	RS435	RSA760
Blower Capacity: (Cubic Feet per Minute)		72	140	435	760
Nominal Fixture Capacity ①: (Cubic Feet per Minute)		54	105	326	380
Max Treatment Capacity: (Cubic Feet per Hour)		3,240	6,300	19,575	22,800
Max Room Size @ 3 Air Changes/Hour: (Cubic Feet)		1,080	2,100	6,525	7,600
Max Room Size @ 4 Air Changes/Hour: (Cubic Feet)		810	1,575	4,894	5,700
Max Room Size @ 5 Air Changes/Hour: (Cubic Feet)		648	1,260	3,915	4,560
Max Room Size @ 6 Air Changes/Hour: (Cubic Feet)		540	1,050	3,263	3,800
Dimensions	Length: (Inches)	34-1/2	34-1/2	47-5/16	61
	Width: (Inches)	7-3/4	7-3/4	14	14
	Height: (Inches)	7-3/4	7-3/4	12	12
Electrical:	Volts: (Volts)	120	120	120	120
	Amps: (Amps)	1.25	2.30	4.52	5.65
	Line Frequency: (Hertz)	50/60	50/60	50/60	50/60
Lamp Data:	Lamp Model:	05-1348-R	05-1348-R	05-1352-R	05-1352-R
	Power Consumption②: (Watts/Lamp)	25	25	32	32
	Ultraviolet Output③: (Watts/Lamp)	8.5	8.5	11.2	11.2

① Fixture capacity incorporates an estimated allowance for airflow friction loss across filter and fixture.

② Wattage is lamp watts only and does not include ballast loss.

③ Ultraviolet output at 254nm at 100 hours and 80°F (approximate).

All specifications, dimensional data, etc. are approximate and subject to change without notice.

REPLACEMENT PARTS

Table 3 – Replacement Parts

NO.	Description	RS72		RS140		RS435		RSA760	
		QTY.	Part No.	QTY.	Part No.	QTY.	Part No.	QTY.	Part No.
1	STER-L-RAY ® Germicidal Ultraviolet Lamp	1	05-1348-R	2	05-1348-R	4	05-1352-R	4	05-1352-R
2	Surelite ™ Electronic Ballast, 120v 50/60Hz	1	10-0137	2	10-0137	4	10-0137	4	10-0137
	Surelite ™ Electronic Ballast, 230v 50/60Hz	1	10-0136	2	10-0136	4	10-0136	4	10-0136
3	Promate ™ Filter: Electrostatic	1	40-7058B	1	40-7058B	2	40-1266B	2	40-1266B
4	Promate ™ Filter: Absolute HEPA	–	–	–	–	–	–	1	40-0021A
5	Promate ™ Filter: Electrostatic	–	–	–	–	–	–	1	40-0034B
6	Promate ™ Blower	1	40-0104A	1	40-1079B	1	40-1078B	1	40-0020B
7	Steadfast ™ Lampholder Set	1	05-1320A-R	2	05-1320A-R	4	05-1320A-R	4	05-1320A-R
8	Interlock Switch	1	35-0128	1	35-0128	1	35-0128	1	35-0128
9	Switch: DPDT 15A	–	–	–	–	1	35-0014	1	35-0014
10	Molded Rubber Bumpers	4	00-1351A	4	00-1351A	6	00-1351A	6	05-1351A
11	Promate ™ Wall Mounting Bracket	2	40-1309A	2	40-1309A	2	40-4210A	2	40-4210A
12	Line Cord, 120v	1	35-1100-R	1	35-1100-R	1	35-1100-R	1	35-1100-R
13	Promate ™ Sight Glass	2	40-1044A1	2	40-1044A1	2	40-1040A1	2	40-1040A1

Other replacement parts are available. Consult the Factory for specific requirements.

REPLACEMENT PARTS

Figure 6 – Replacement Parts List for **SANITAIRE®** Model RS72 & RS140

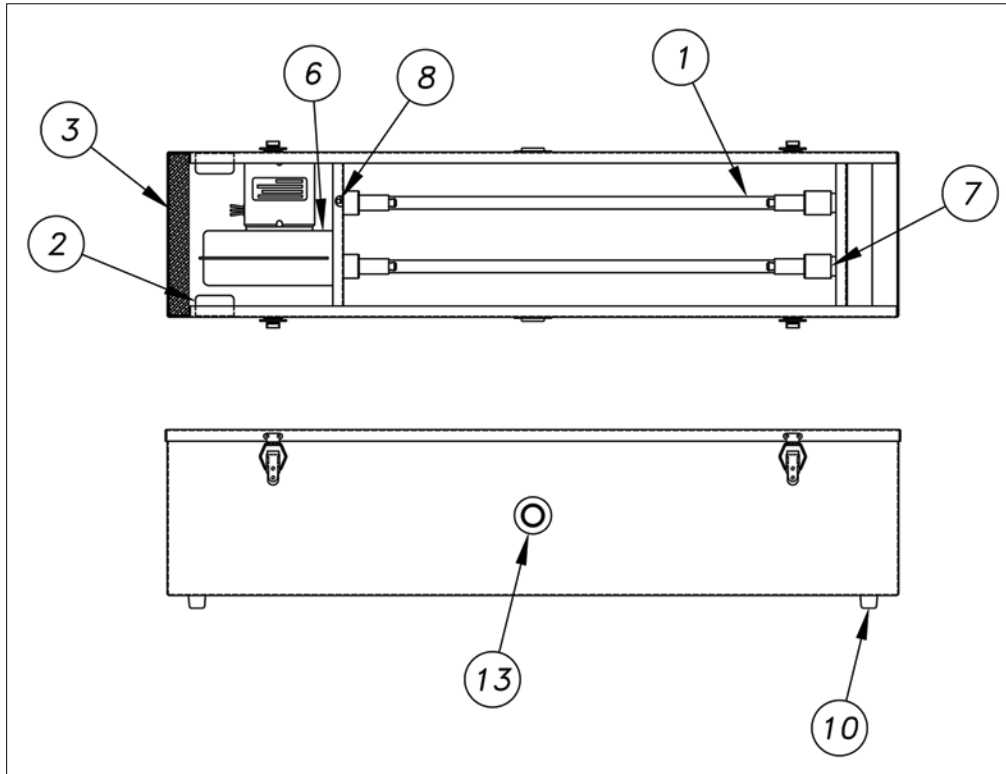

Note: Model RS72 has only 1 lamp, 1 lampholder set, and 1 ballast

Figure 7 – Replacement Parts List for **SANITAIRE®** Model RS435 & RSA760

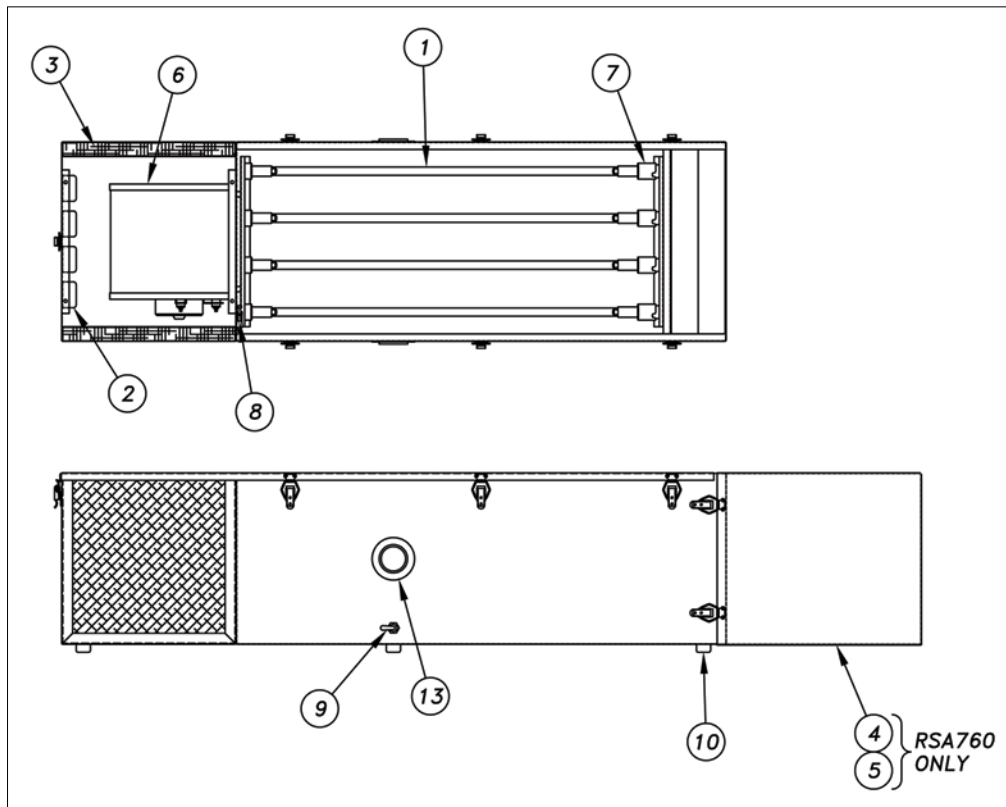

MAINTENANCE NOTES

MAINTENANCE NOTES

USER ASSISTANCE

Atlantic Ultraviolet Corporation® makes every effort to ensure that the **SANITAIRE®** Germicidal Ultraviolet Room Air Sanitizer is a product of superior quality and workmanship. This manual describes the installation, operation and maintenance of the **SANITAIRE®** Germicidal Ultraviolet Room Air Sanitizer.

Please read and become familiar with the contents of this manual before installing or using this unit. If after reading the manual you still have questions, or concerns, regarding the installation or use of this unit, contact our offices, weekdays between 8:30 am and 5:00 pm Eastern Time, at:

Atlantic Ultraviolet Corporation®
375 Marcus Boulevard
Hauppauge, New York, 11788
Tel: (631) 273-0500
Fax: (631) 273-0771
Email: Sales@AtlanticUV.com
Shop: AtlanticUltraviolet.com
Learn More: Ultraviolet.com

PATENT NOTICE

No attempt has been made to determine the patent status of applications illustrated or described in this publication. Inclusion in this publication of any design or method of use, which may be patented, is not to be construed as promoting or sanctioning unauthorized use.

WARRANTY & PRODUCT REGISTRATION

We warrant this product to the original owner to be free from defects in material and workmanship when installed in accordance with Atlantic Ultraviolet Corporation® specifications for a period of time as follows:

UV Water Purifier Chambers – Type 316 stainless steel chambers will have a Twelve (12) year Limited Warranty on the stainless steel chamber, from the date of original purchase while the Type 304 stainless steel chambers will have a Six (6) year Limited Warranty on the stainless steel chamber.

UV Air Disinfection Housing – Three (3) year Limited Warranty on the metal housing, from the date of original purchase.

Ballasts – Three (3) year Limited Warranty, from the date of original purchase.

UV Lamps, Monitoring Devices, Optional Accessories, and Other Parts – One (1) year Limited Warranty from the date of original purchase.

Within the warranty period we shall repair or replace such products, which are returned to us with shipping charges prepaid and which are determined by us to be defective. This warranty will not apply to any product, which has been subjected to misuse, negligence or accident; or misapplied; or modified; or repaired by unauthorized person; or improperly installed. Warranty will be null and void if any of the product's original labels are removed. This Limited warranty excludes the cost of labor.

The Buyer shall inspect the product promptly after receipt and shall notify us at our main office in writing of claims, including claims of breach of warranty, within thirty (30) days after the Buyer discovers or should have discovered the facts upon which the claim is based. Failure of the Buyer to give written notice of a claim within the time period shall be deemed to be a waiver of such claim.

The provisions of the above warranty are our sole obligation and exclude all other remedies or warranties, expressed or implied, including warranties of merchantability and fitness for a particular purpose, whether or not purposes or specifications are described herein. We further disclaim any responsibility whatsoever to the customer, or to any person for injury to person, damage to, or loss of property or value caused by any product which has been subjected to misuse, negligence, accident; or modified or repaired by unauthorized persons; or improperly installed.

Under no circumstances shall the Company be liable for any incidental, consequential or special damages; losses or expenses arising from the contract for this product, or in connection with the use of, or inability to use, our product for any purpose whatsoever.

Be sure to register your product and validate purchase within 30 days –registration is simple and will take less than 2 minutes to do.

NOTE – failure to register your purchase may jeopardize warranty.

Go to AtlanticUltraviolet.com and scroll down to the bottom of the page, under “Trust,” and click “Warranty Registration Form.” Complete form and click “Submit.” Or email us at Sales@AtlanticUV.com for a PDF of the warranty registration card, which you can print and mail to 375 Marcus Boulevard, Hauppauge, NY 11788, or fax to (631) 273-0771. If you prefer to register by phone, please call (631) 273-0500 and our customer service staff will be glad to assist you.

For your convenience, record the following information below. The model and serial number can be found on a label located on the **SANITAIRE®** Germicidal Ultraviolet Room Air Sanitizer. Keep this manual, along with proof of purchase, handy when contacting our offices.

Purchased From:	Date:
Model:	Serial No.: