

## Features

- Ultra High Efficiency (Up to 94.5%)
- Full Power at 70-100% Max Current (Constant Power)
- 0-10V/PWM/Timer Dimmable and Dim-to-Off
- Standby Power  $\leq 1.5W$
- Input Surge Protection: 4kV line-line, 6kV line-earth
- All-Around Protection: OVP, SCP, OTP
- Suitable for UL Dry / Damp / Wet Location
- TYPE HL, for use in a Class I, Division 2 hazardous (Classified) location



## Description

The ESD-320SxxxDT series is a 320W, constant-current, programmable outdoor LED driver that operates from 249-528 Vac input with excellent power factor. Created for high bay, high mast, arena and roadway lights, it provides a dim-to-off mode with low standby power. The high efficiency of these drivers and compact metal case enables them to run cooler, significantly improving reliability and extending product life. To ensure trouble-free operation, protection is provided against input surge, output over voltage, short circuit, and over temperature.

## Models

Output Current Range	Full-Power Current Range (1)	Default Output Current	Input Voltage Range	Output Voltage Range	Max. Output Power	Typical Efficiency (2)	Power Factor		Model Number
							277Vac	480Vac	
105-1500mA	1050-1500mA	1400 mA	249~528Vac	107~305Vdc	320 W	94.0%	0.96	0.95	ESD-320S150DT
154-2200mA	1540-2200mA	2100 mA	249~528Vac	73~208Vdc	320 W	94.5%	0.96	0.95	ESD-320S220DT
217-3100mA	2170-3100mA	2800 mA	249~528Vac	52~148Vdc	320 W	94.0%	0.96	0.95	ESD-320S310DT
308-4400mA	3080-4400mA	4200 mA	249~528Vac	37~104Vdc	320 W	94.0%	0.96	0.95	ESD-320S440DT
434-6200mA	4340-6200mA	4900 mA	249~528Vac	26 ~74Vdc	320 W	93.5%	0.96	0.95	ESD-320S620DT

Notes: (1) Output current range with constant power at 320W

(2) Measured at a 480Vac input with 70% maximum output current or 100% maximum output voltage.

## I-V Operating Area

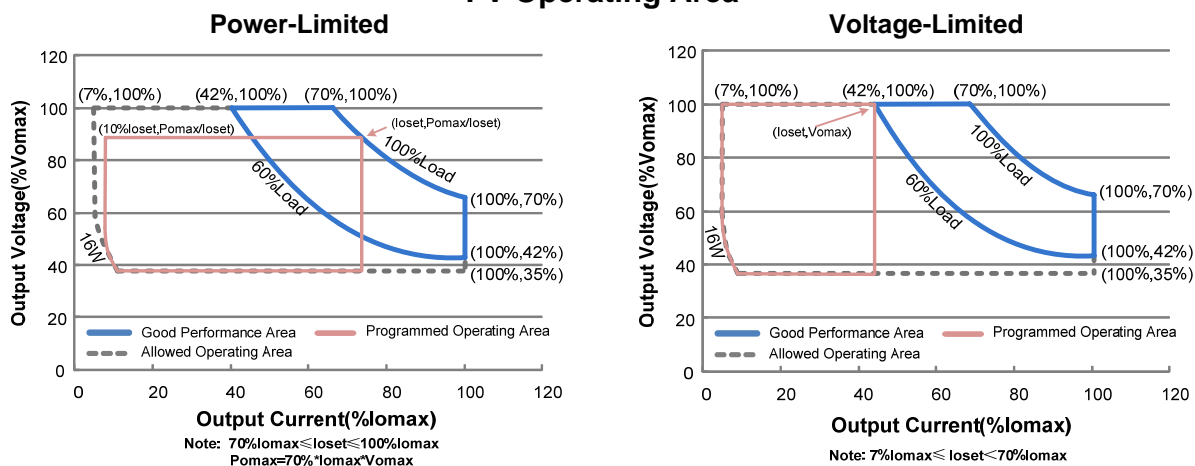

## Input Specifications

Parameter	Min.	Typ.	Max.	Notes
Input Voltage	249 Vac	-	528 Vac	
Input Frequency	47 Hz	-	63 Hz	
Leakage Current	-	-	1.0 mA	At 480Vac 60Hz input; Grounding effectively.
Input AC Current	-	-	1.5 A	Measured at full load and 277 Vac input.
	-	-	0.8 A	Measured at full load and 480 Vac input.
Inrush Current(I <sup>2</sup> t)	-	-	3.87 A <sup>2</sup> s	At 480Vac input, 25°C Cold Start, Duration=1.77 ms, 10%I <sub>pk</sub> -10%I <sub>pk</sub> . See Inrush Current Waveform for the details.
PF	0.90	-	-	At 277-480Vac, 60%-100% Load (192-320W)
THD	-	-	20%	

## Output Specifications

Parameter	Min.	Typ.	Max.	Notes
Output Current Tolerance	-5%loset	-	5%loset	At full load condition
Output Current Setting(loset) Range	7%lomax	-	100%lomax	
Output Current Setting Range with Constant Power	70%lomax	-	100%lomax	
Total Output Current Ripple (pk-pk)	-	5%lomax	10%lomax	At full load condition, 20 MHz BW
Output Current Ripple at < 200 Hz (pk-pk)	-	2%lomax	-	At full load condition. Only this component of ripple is associated with visible flicker.
Startup Overshoot Current	-	-	10%lomax	At full load condition
No Load Output Voltage				
ESD-320S150DT	-	-	329V	
ESD-320S220DT	-	-	223V	
ESD-320S310DT	-	-	158V	
ESD-320S440DT	-	-	121V	
ESD-320S620DT	-	-	84V	
Line Regulation	-	-	±0.5%	Measured at full load
Load Regulation	-	-	±1.5%	
Turn-on Delay Time	-	1.0 s	2.0 s	Measured at 277Vac and 480Vac input.
Temperature Coefficient of loset	-	-	0.03%/°C	Case temperature = 0°C ~T <sub>c</sub> max
12V Auxiliary Output Voltage	10.8 V	12 V	13.2 V	
12V Auxiliary Output Source Current	0 mA	-	200 mA	Return terminal is "Dim"

**Note:** All specifications are typical at 25°C unless otherwise stated.

## General Specifications

Parameter	Min.	Typ.	Max.	Notes
Efficiency at 277 Vac input: ESD-320S150DT Io=1050mA Io=1500mA ESD-320S220DT Io=1540mA Io=2200mA ESD-320S310DT Io=2170mA Io=3100mA ESD-320S440DT Io=3080mA Io=4400mA ESD-320S620DT Io=4340mA Io=6200mA	90.5% 89.5% 91.0% 90.0% 90.5% 90.0% 91.0% 90.0% 90.5% 89.5%	92.5% 91.5% 93.0% 92.0% 92.5% 92.0% 93.0% 92.0% 92.5% 91.5%	- - - - - - - - - -	Measured at full load and steady-state temperature in 25°C ambient; (Efficiency will be about 2.0% lower if measured immediately after startup.)
Efficiency at 347 Vac input: ESD-320S150DT Io=1050mA Io=1500mA ESD-320S220DT Io=1540mA Io=2200mA ESD-320S310DT Io=2170mA Io=3100mA ESD-320S440DT Io=3080mA Io=4400mA ESD-320S620DT Io=4340mA Io=6200mA	91.5% 90.5% 92.0% 91.0% 91.5% 90.5% 91.5% 90.5% 91.0% 90.0%	93.5% 92.5% 94.0% 93.0% 93.5% 92.5% 93.5% 92.5% 93.0% 92.0%	- - - - - - - - - -	Measured at full load and steady-state temperature in 25°C ambient; (Efficiency will be about 2.0% lower if measured immediately after startup.)
Efficiency at 480 Vac input: ESD-320S150DT Io=1050mA Io=1500mA ESD-320S220DT Io=1540mA Io=2200mA ESD-320S310DT Io=2170mA Io=3100mA ESD-320S440DT Io=3080mA Io=4400mA ESD-320S620DT Io=4340mA Io=6200mA	92.0% 91.0% 92.5% 91.5% 92.0% 91.0% 92.0% 91.0% 91.5% 90.5%	94.0% 93.0% 94.5% 93.5% 94.0% 93.0% 94.0% 93.0% 93.5% 92.5%	- - - - - - - - - -	Measured at full load and steady-state temperature in 25°C ambient; (Efficiency will be about 2.0% lower if measured immediately after startup.)
Standby power	-	-	1.5 W	Measured at 480Vac/50Hz; Dimming off
MTBF	-	200,000 Hours	-	Measured at 480Vac input, 80%Load and 25°C ambient temperature (MIL-HDBK-217F)
Lifetime	-	110,000 Hours	-	Measured at 480Vac input, 80%Load and 60°C case temperature; See lifetime vs. Tc curve for the details

## General Specifications (Continued)

Parameter	Min.	Typ.	Max.	Notes
Operating Case Temperature for Safety Tc_s	-40°C	-	87°C	
Operating Case Temperature for Warranty Tc_w	-40°C	-	70°C	
Storage Temperature	-40°C	-	+85°C	Humidity: 5%RH to 100%RH
Dimensions Inches (L x W x H) Millimeters (L x W x H)	9.21 x 3.86 x 1.75 234 x 98 x 44.5			
Net Weight	-	1750g	-	

**Note:** All specifications are typical at 25°C unless otherwise stated.

## Dimming Specifications

Parameter	Min.	Typ.	Max.	Notes
Absolute Maximum Voltage on the Vdim (+) Pin	-20 V	-	20 V	
Source Current on Vdim (+)Pin	200 uA	300 uA	450 uA	Vdim(+) = 0 V
Dimming Output Range	10%I <sub>oSet</sub>	-	I <sub>oSet</sub>	70%I <sub>oMax</sub> ≤ I <sub>oSet</sub> ≤ 100%I <sub>oMax</sub>
	7%I <sub>oMax</sub>	-	I <sub>oSet</sub>	7%I <sub>oMax</sub> ≤ I <sub>oSet</sub> < 70%I <sub>oMax</sub>
Recommended Dimming Input Range	0 V	-	10 V	Default 0-10V dimming mode.
Dim off Voltage	0.4 V	0.55V	0.7 V	
Dim on Voltage	0.6 V	0.75 V	0.9 V	
Hysteresis	-	0.2 V	-	
PWM_in High Level	3 V	-	10 V	Dimming mode set to PWM in PC interface.
PWM_in Low Level	-0.3 V	-	0.6 V	
PWM_in Frequency Range	200 Hz	-	3 KHz	
PWM_in Duty Cycle	1%	-	99%	
PWM Dimming off (Positive Logic)	3%	5%	8%	
PWM Dimming on (Positive Logic)	5%	7%	10%	
PWM Dimming off ( Negative Logic)	92%	95%	97%	
PWM Dimming on ( Negative Logic)	90%	93%	95%	
Hysteresis	-	2%	-	

**Note:** All specifications are typical at 25 °C unless stated otherwise.

## Safety & EMC Compliance

Safety Category	Standard
UL/CUL	UL8750,CAN/CSA-C22.2 No. 250.13-12
EMI Standards	Notes
FCC Part 15	ANSI C63.4:2009 Class B
	This device complies with Part 15 of the FCC Rules. Operation is subject to the following two conditions: (1) this device may not cause harmful interference, and (2) this device must accept any interference received, including interference that may cause undesired Operation.
EMS Standards	Notes
EN 61000-4-2	Electrostatic Discharge (ESD): 8 kV air discharge, 4 kV contact discharge
EN 61000-4-3	Radio-Frequency Electromagnetic Field Susceptibility Test-RS
EN 61000-4-4	Electrical Fast Transient / Burst-EFT
EN 61000-4-5	Surge Immunity Test: AC Power Line: line to line 4 kV, line to earth 6 kV
EN 61000-4-6	Conducted Radio Frequency Disturbances Test-CS
EN 61000-4-8	Power Frequency Magnetic Field Test
EN 61000-4-11	Voltage Dips
EN 61547	Electromagnetic Immunity Requirements Applies To Lighting Equipment

## Lifetime vs. Case Temperature

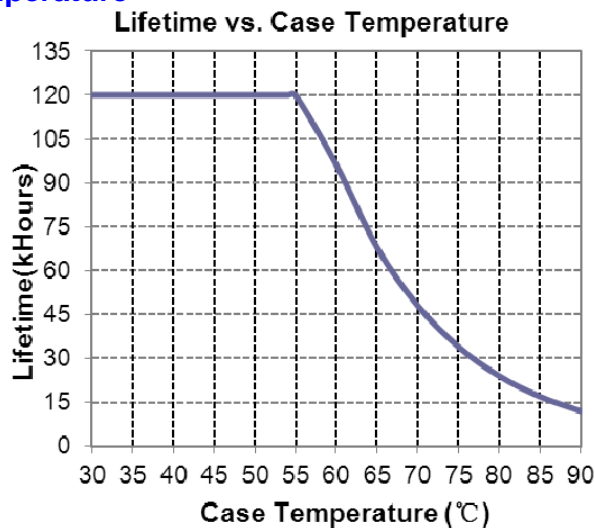

## Inrush Current Waveform

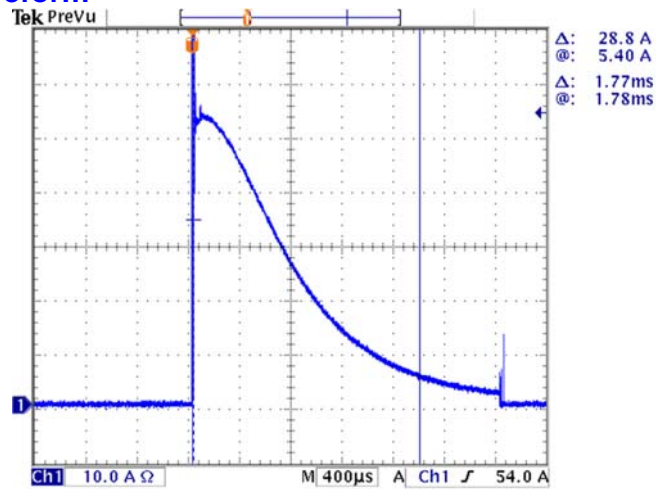

## Efficiency vs. Load

ESD-320S150DT (I<sub>o</sub>=1050mA)  
Efficiency vs. Output Voltage

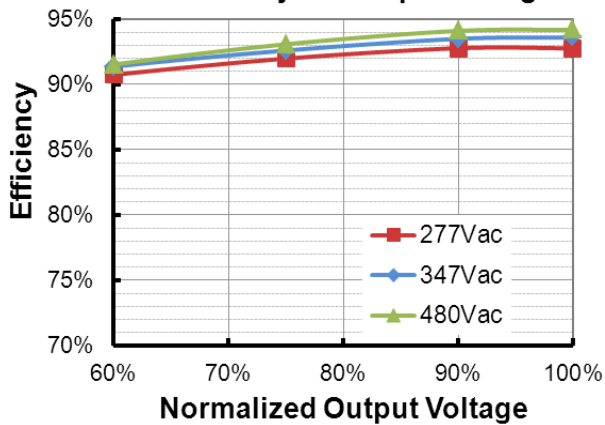

ESD-320S150DT (I<sub>o</sub>=1500mA)  
Efficiency vs. Output Voltage

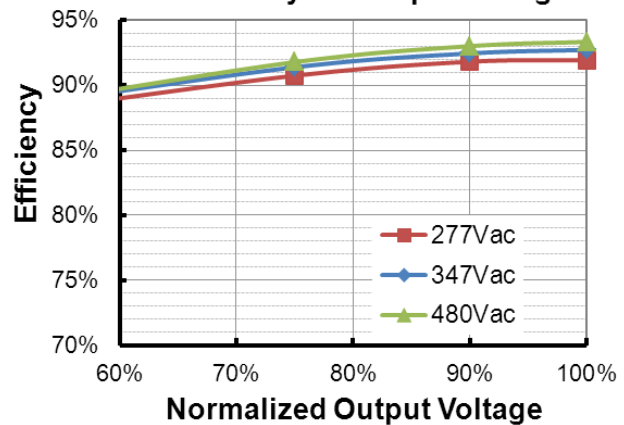

ESD-320S220DT (I<sub>o</sub>=1540mA)  
Efficiency vs. Output Voltage

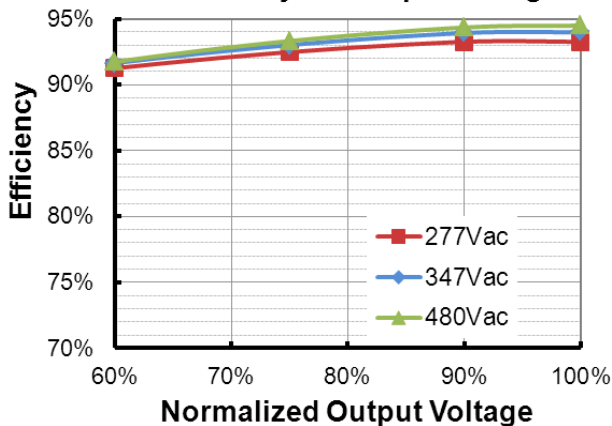

ESD-320S220DT (I<sub>o</sub>=2200mA)  
Efficiency vs. Output Voltage

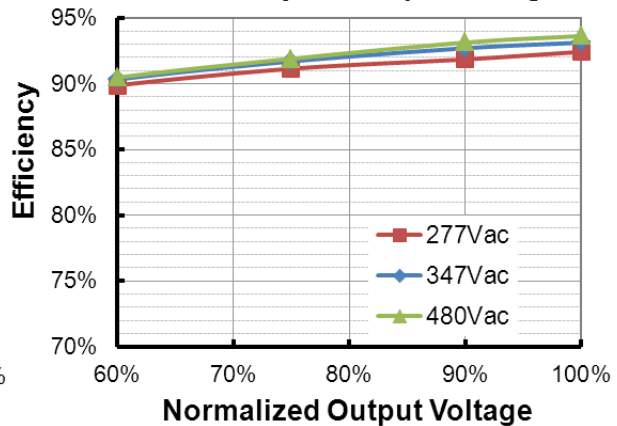

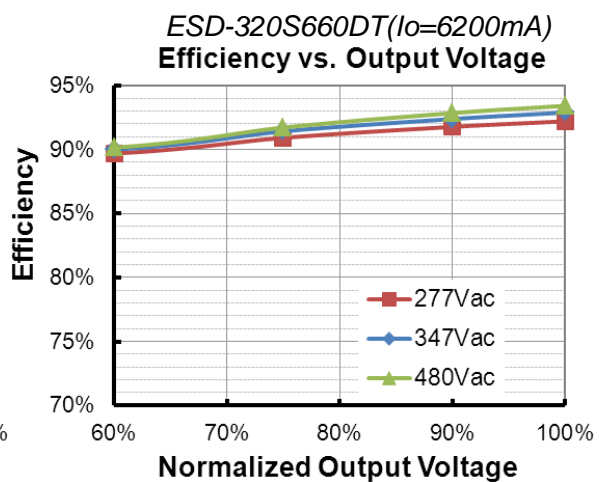
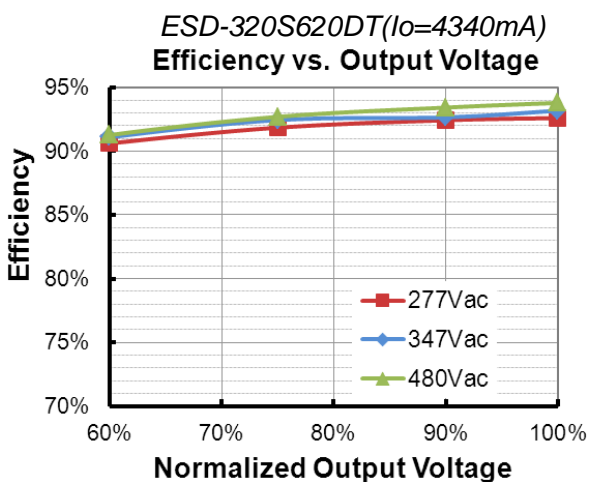
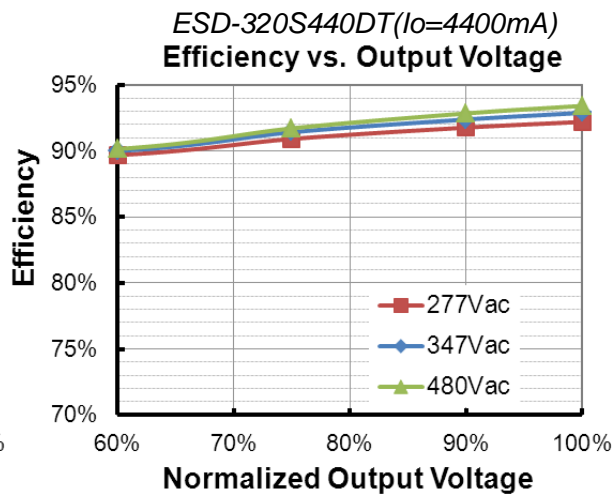
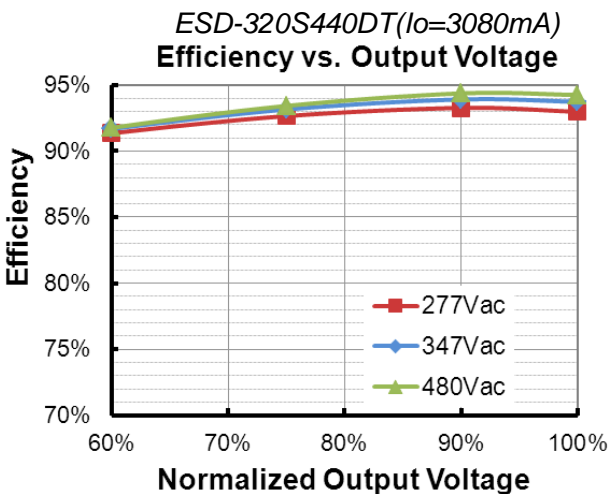
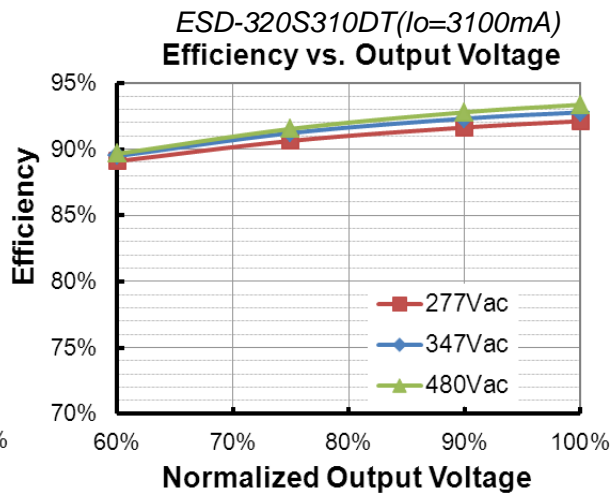
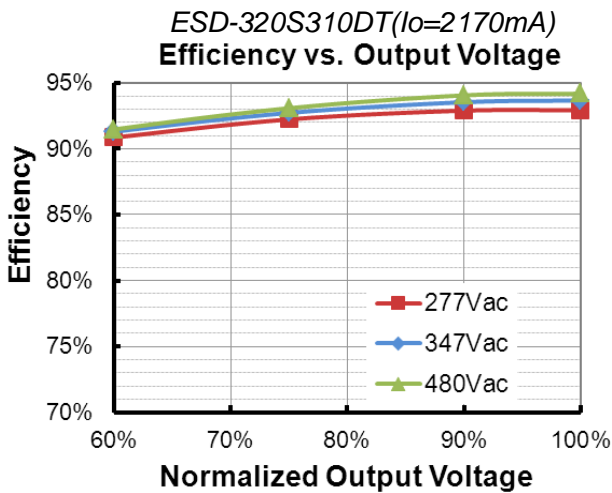



## Power Factor

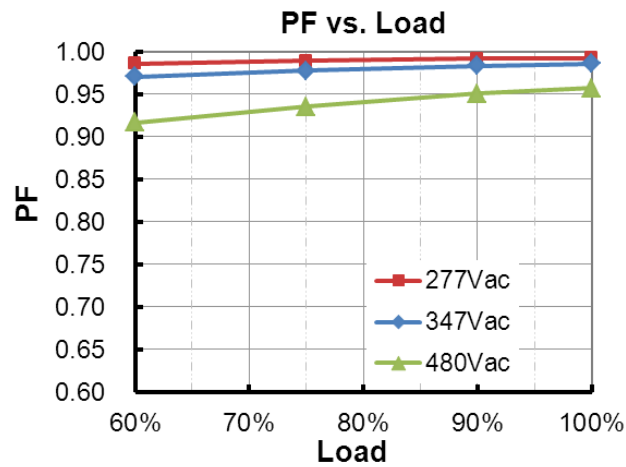

## Total Harmonic Distortion

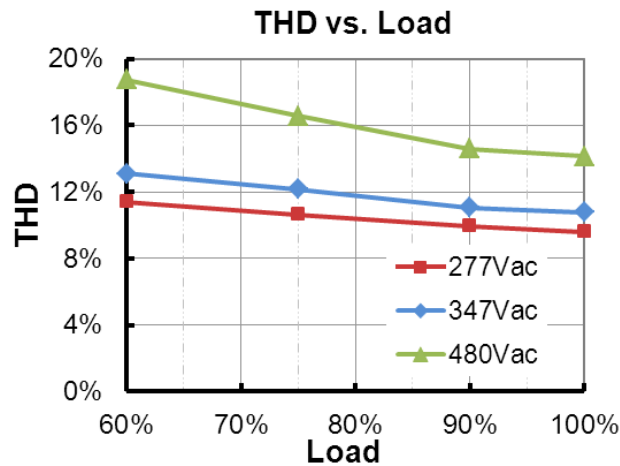

## Protection Functions

Parameter	Notes
Over Temperature Protection	Decreases output current, returning to normal after over temperature is removed.
Short Circuit Protection	Auto Recovery. No damage will occur when any output is short circuited. The output shall return to normal when the fault condition is removed.
Over Voltage Protection	Limits output voltage at no load and in case the normal voltage limit fails.

## Dimming

### ● 0-10V Dimming

The recommended implementation of the dimming control is provided below.



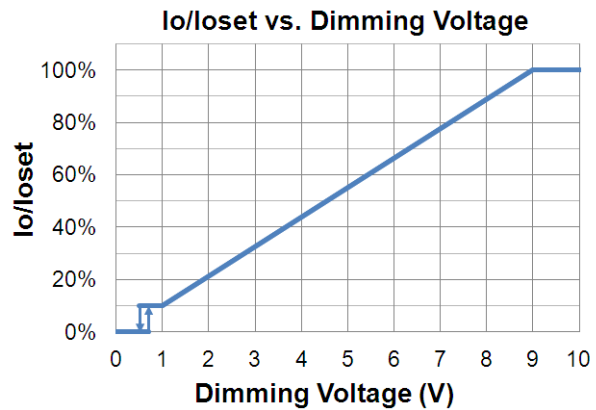
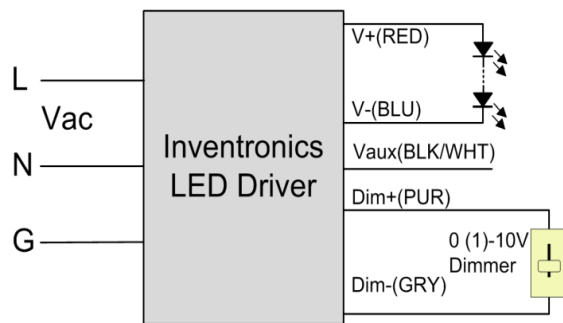

**Implementation 1: DC Input**

**Notes:**

1. The dimmer can also be replaced by an active 0-10V voltage source signal or passive components like resistors and zener.
2. Do NOT connect Dim- to the output V- or V+, otherwise the driver will not work properly.
3. If 0-10V dimming is not used, Dim + should be open.

● **PWM Dimming**

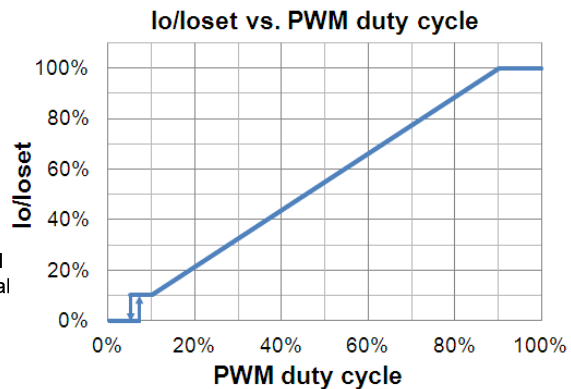
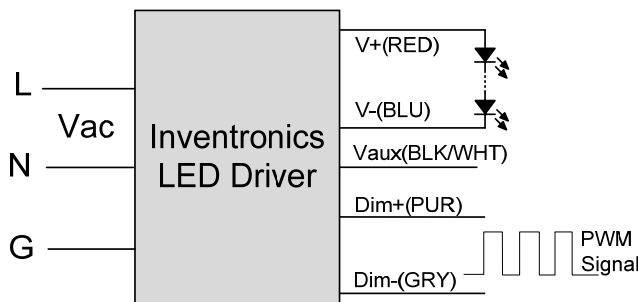

**Implementation 2: Positive logic**

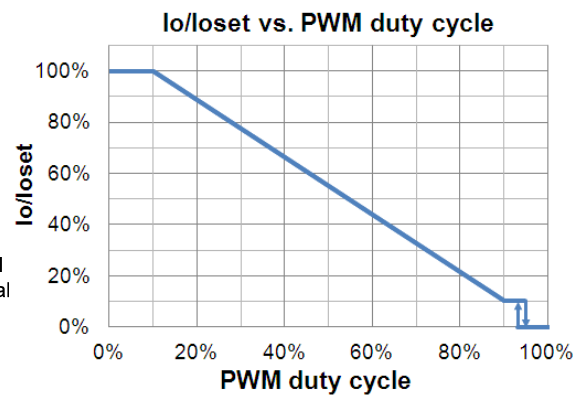
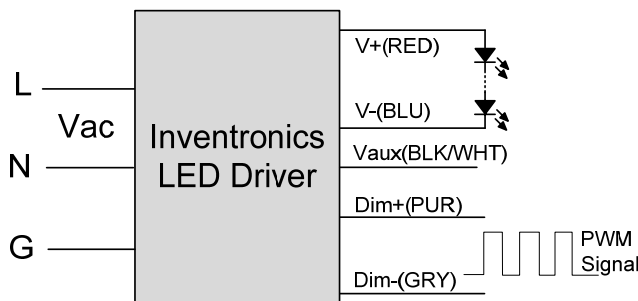

**Implementation 3: Negative logic**

## ● Time Dimming

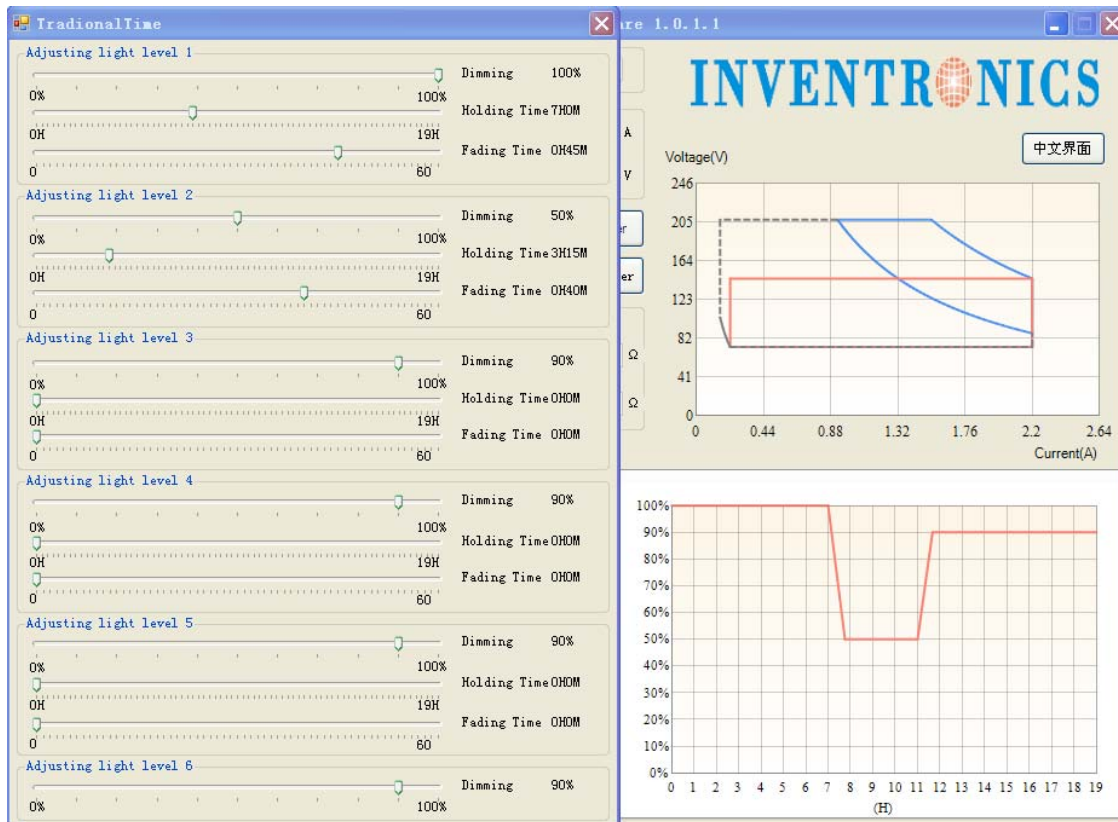

Set the timing curve by pulling the sliders.

## Programming Connection Diagram

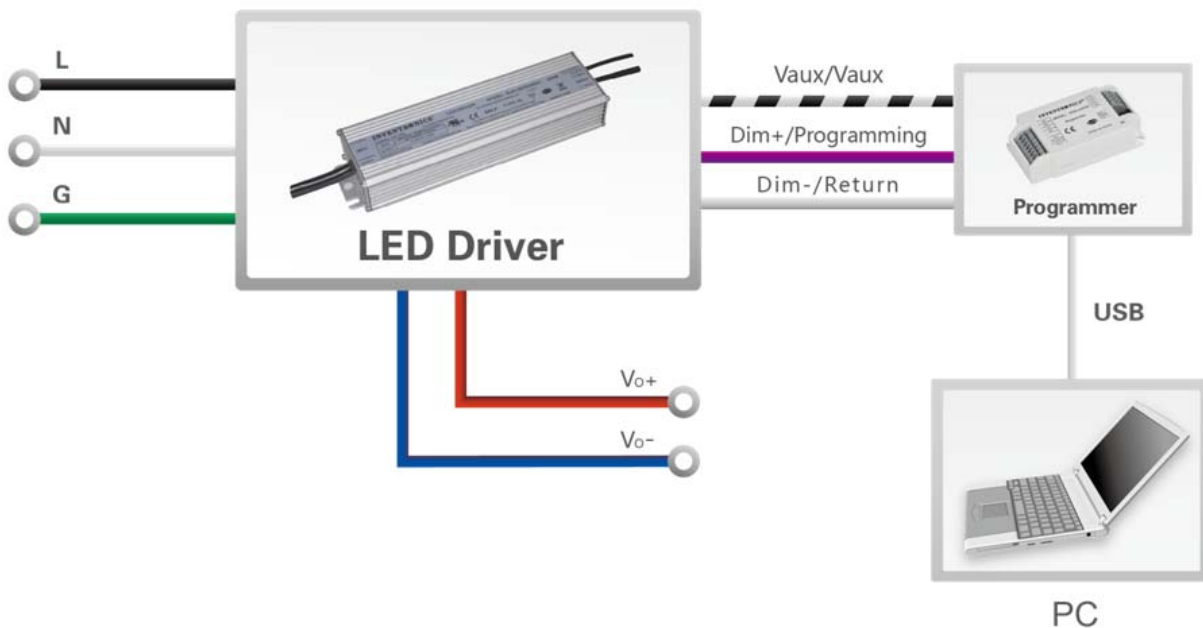

**Note:** The driver does not need to be powered on during the programming process.

- Please refer to [PRG-MUL2 Multi-Programmer datasheet](#) for details.

## Mechanical Outline

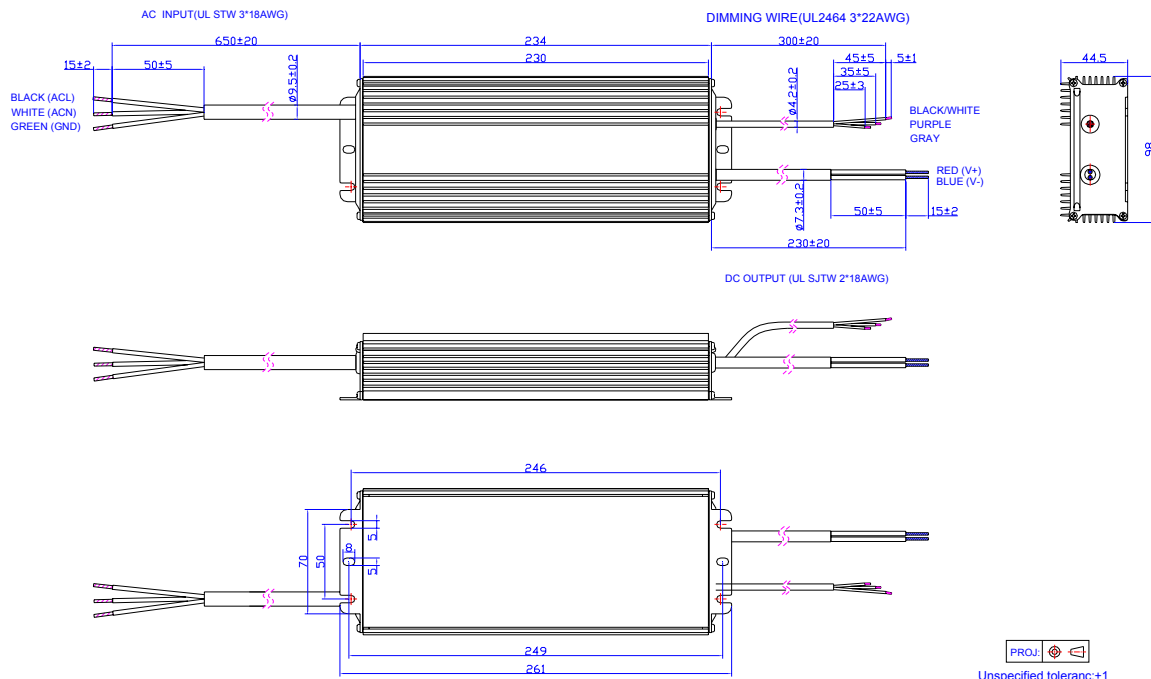

## RoHS Compliance

Our products comply with the European Directive 2011/65/EC, calling for the elimination of lead and other hazardous substances from electronic products.

## Revision History

Change Date	Rev.	Description of Change		
		Item	From	To
2015-01-14	A	Datasheets Release	/	/
2015-03-09	B	Features	Input Surge Protection: 4kV line-line, 6kV line-earth	Added
		Model: ESD-320S150DT	/	Added
		Output Current Ripple(pk-pk)	Output Current Ripple(pk-pk)	Total Output Current Ripple (pk-pk)
		Output Current Ripple at < 200 Hz (pk-pk)	/	Added
		Operating Case Temperature for Safety Tc_s	/	Updated
		Operating Case Temperature for Warranty Tc_w	/	Updated
		General Specifications	Storage Temperature	Added
		Environmental Specifications	/	Delete
		Derating	/	Delete