









## Assembly Instruction

PARTS								
QTY	2	1	4	4	1	3	3	3

★  
A SCREWDRIVER WILL  
BE NEEDED TO  
COMPLETE ASSEMBLY

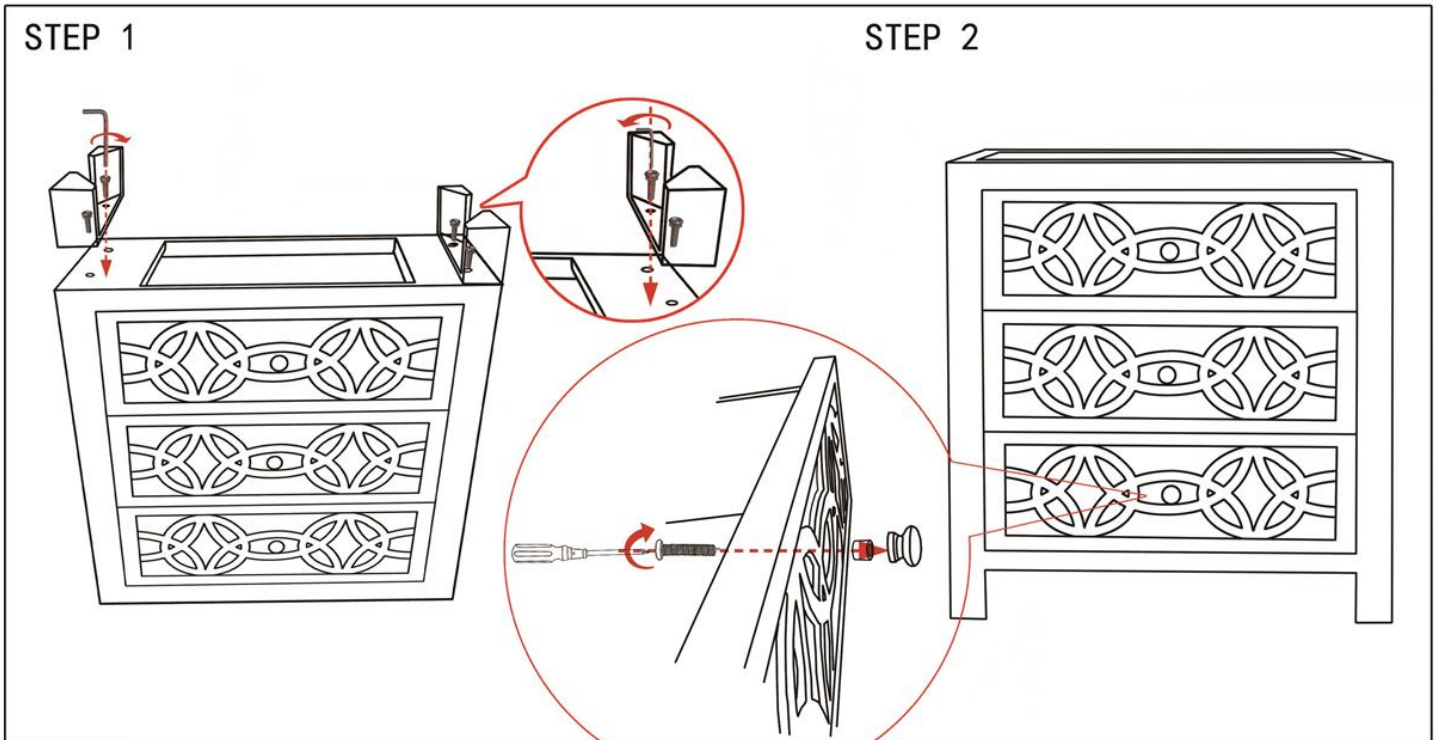

To prevent damage during transit, the drawer knobs have been packed in the same box as the legs

**Instructions:**



1. Using the supplied drawer rope, gently pull open each drawer
2. Remove the rope from the drawer and discard
3. After opening the drawers and removing the rope, please follow the instructions in the diagram below to install the drawer knobs



**Attention**

The MAXIMUM weight capacity for this item is 25lbs.  
DO NOT exceed the maximum capacity.  
DO NOT sit on this item.  
Failure to comply could cause breakage and/ or injury.

## Knobs Assembly

PARTS	<b>A</b> 	<b>B</b> 	<b>C</b> 	
QTY	3	3	3	

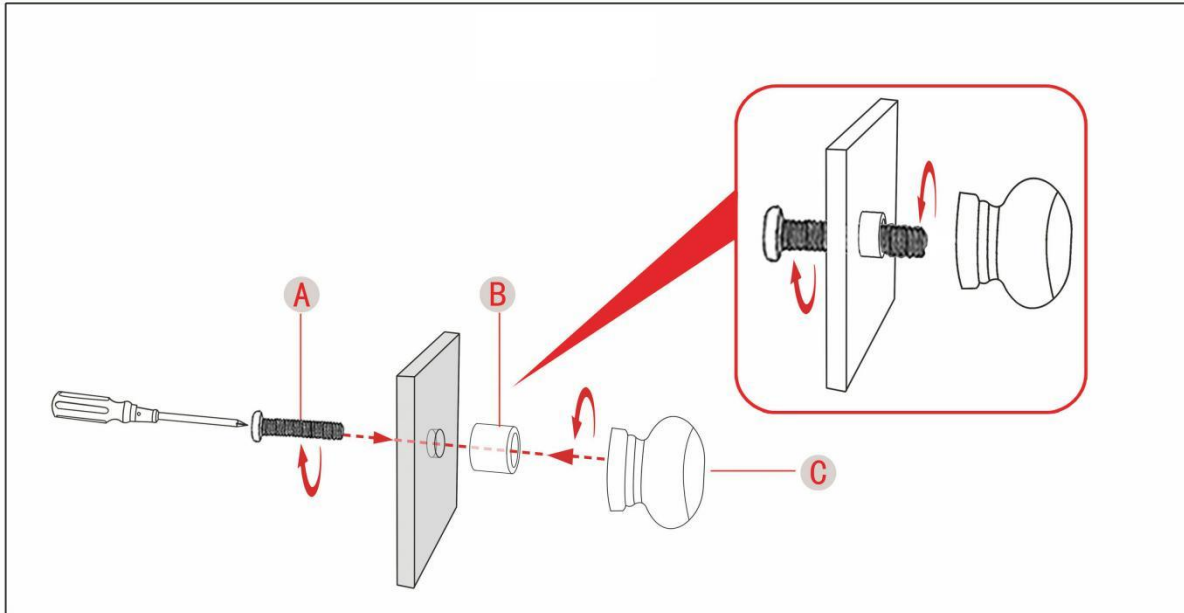

**WARNING: To prevent any cracking or breaking of the mirror, please do not overtighten the knobs during installation**

**Made In China**