



		Part Description	Quantity
G5687	1	 Chair Backrest & Seat	1
	2	 Frame	1
	3	 Glide (φ15*13)	4
	HDWR	Hardware pack	1



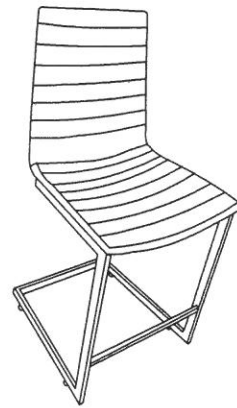
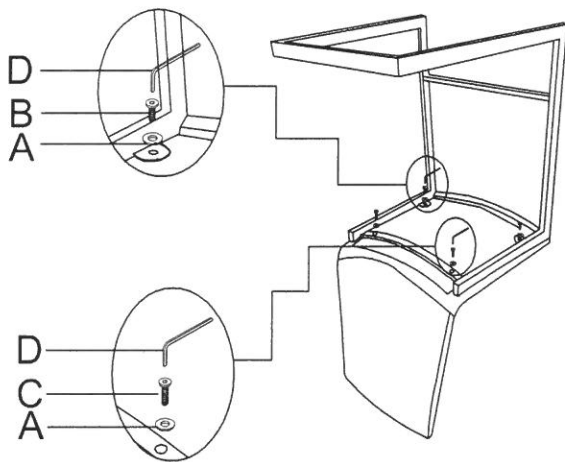

ASSEMBLY INSTRUCTION

ITEM NAME:SPRINT MODEL NUMBER: G5687 CHAIR

STEP 1



Note: Please do not tighten all bolts until the item is fully assembled. Once assembled tighten all bolts.
Not for commercial use.

G5687 HARDWARE			
A	X4		Φ6*18
B	X2		M6x15
C	X2		M6*25
D	X1		M5