





ASSEMBLY INSTRUCTIONS

PARTS LIST

A		NUT	5/16*5.5	8 PCS
B		BOLT	5/16*2-1/4"	4 PCS
C		FLAT WASHER	5/16*19	12 PCS
D		LOCK WASHER	5/16*14	12 PCS
E		SPANNER	5/16	1 PC

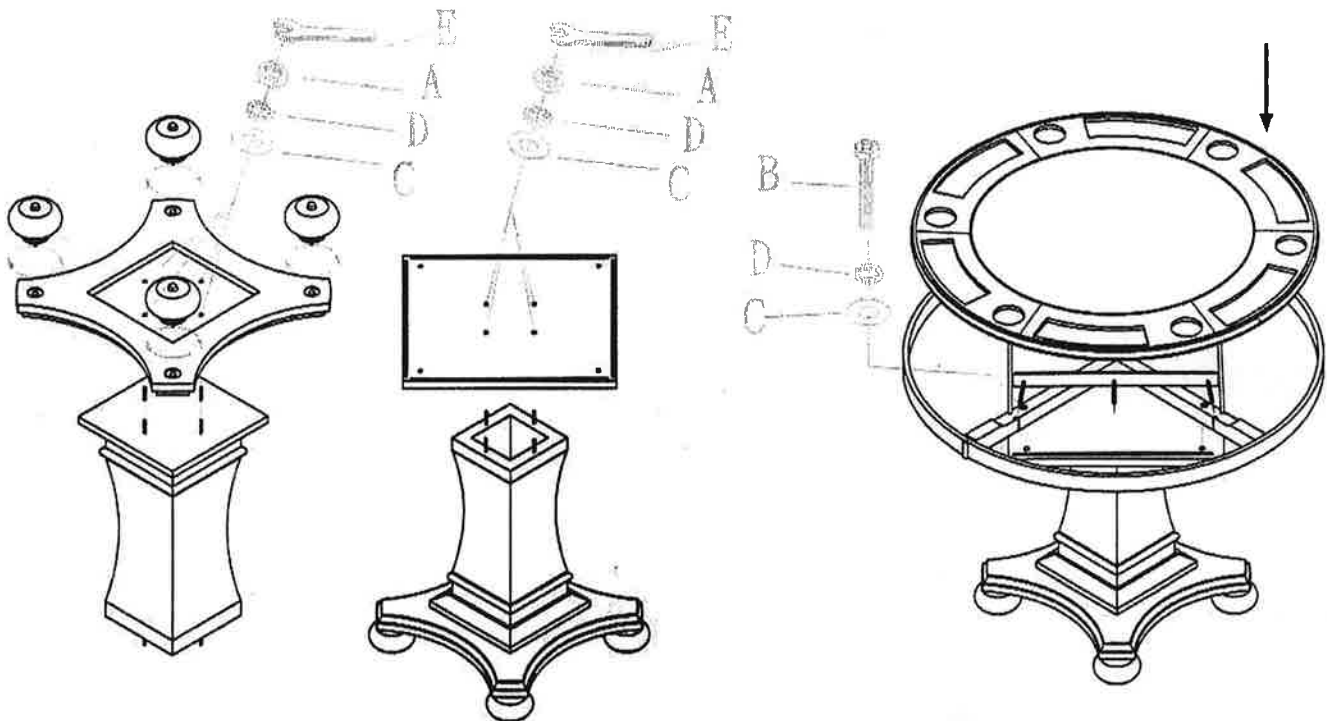
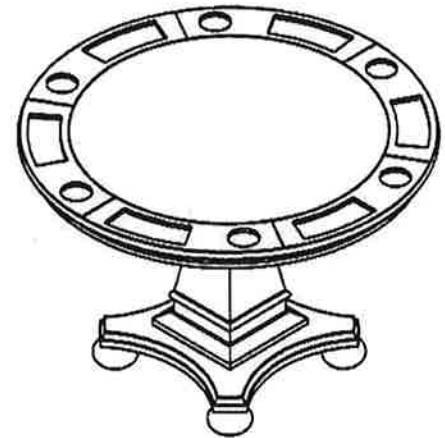

SINCE HARDWOODS AND VENEERS ARE USED IN THIS FURNITURE, THERE MAY BE VARIATIONS IN COLOR, SHADE AND PATTERN. WOOD IS A NATURAL MATERIAL, NO TWO PIECES OF WOOD OR VENEER ARE EXACTLY ALIE. AS A RESULT EACH PIECE TAKES THE STAIN DIFFERNTLY. IT IS THIS VARIATION THAT MAKES WOOD AND VENEER SO BEAUTIFUL.

TO CLEAN:TREAT THIS FURNITURE AS YOU WOULD ANY FINE FURNITURE. DUST WITH A CLEAN SOFT CLOTH AND USE A HIGH QUALITY FURNITURE POLISH. DO NOT USE ANY CLEANERS CONTAINING ALCOHOLS, ACETONES, OR OTHER STRONG SOLVENTS.