

## UNIVERSAL SEALS

DENSE RUBBER SEALS .....	2
SPONGE RUBBER SEALS .....	10
EDGING SEALS .....	14
PEEL-N-STICK SEALS .....	15
PUSH-ON SEALS .....	18
GLASS RUN CHANNELS .....	19
BELTLINE .....	22

## GROMMETS, BUMPERS & PLUGS

GROMMETS .....	23
BUMPERS .....	24
PLUGS .....	25

## RV & MARINE

RV WEATHERSTRIPPING .....	24
MARINE WEATHERSTRIPPING .....	25

## GENERAL USE PARTS

RUBBER SHEETING .....	26
FENDER WELTING .....	26
RUBBER BUSHINGS .....	26
RUBBER PADS .....	27

## ACCESSORIES

ADHESIVES, CLEANERS & SEALERS .....	28
TOOLS .....	29

## INFORMATION

PRICE LIST .....	30 & 31
CUSTOMER SERVICE .....	32



Since 1958



Steele Rubber Products 6180 E NC 150 HWY Denver NC 28037

[www.steelerubber.com](http://www.steelerubber.com)



**DENSE RUBBER SEALS**  
SPONGE RUBBER SEALS ON PAGE 10

**How To Order**

All of our universal seals, on pages 2-13, are sold "by the foot". Simply let us know how many feet you require, and we will cut to your custom length.

**Possible Uses:**  
Many of the seals on these pages are perfect for holding glass in a metal track, providing safety and great finishing looks.

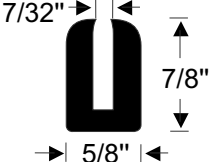
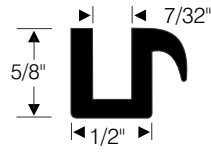
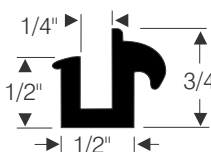
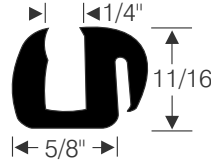
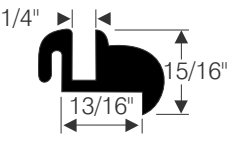
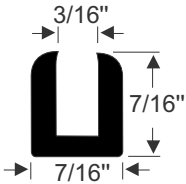
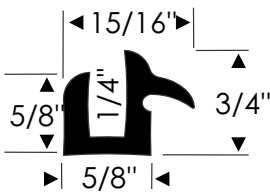
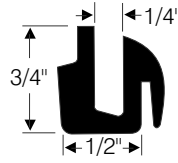
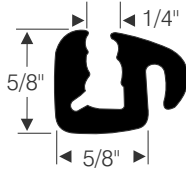
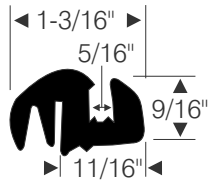
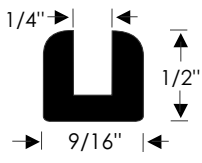
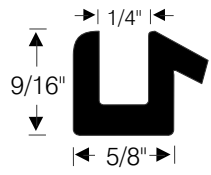
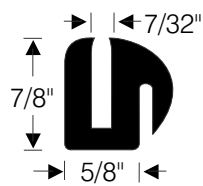
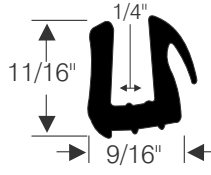
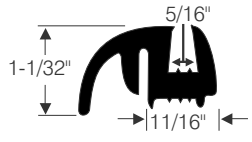
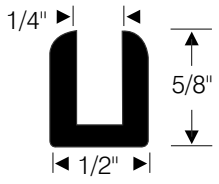
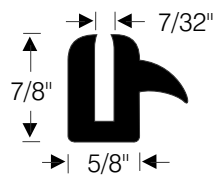
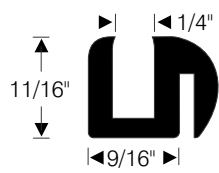
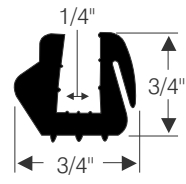

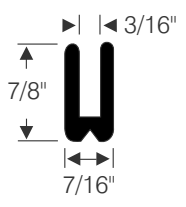
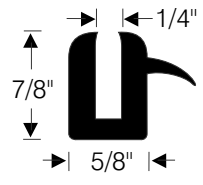
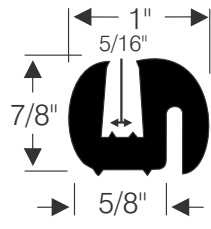
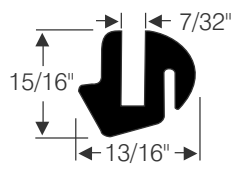
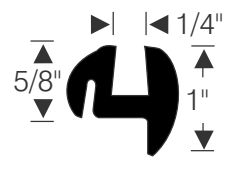
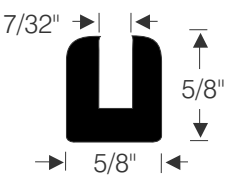
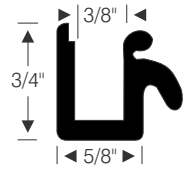
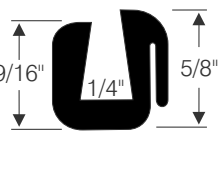
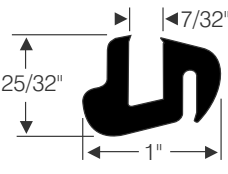
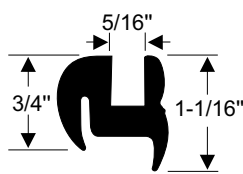
 <p><b>70-1192-52</b></p>	 <p><b>30-0086-99</b></p>	 <p><b>70-1189-52</b></p>	 <p><b>30-0512-99</b></p>	 <p><b>18-0004-77</b></p>
 <p><b>30-0044-77</b></p>	 <p><b>70-1297-99</b></p>	 <p><b>40-0053-99</b></p>	 <p><b>70-1796-99</b></p>	 <p><b>60-0687-99</b></p>
 <p><b>70-0084-99</b></p>	 <p><b>70-1195-52</b></p>	 <p><b>70-1190-52</b></p>	 <p><b>70-3245-99</b></p>	 <p><b>50-0392-99</b></p>
 <p><b>30-0478-99</b></p>	 <p><b>70-1188-52</b></p>	 <p><b>40-0359-99</b></p>	 <p><b>70-3286-99</b></p>	 <p><b>50-0333-99</b></p>
 <p><b>30-0020-99</b></p>	 <p><b>70-1191-52</b></p>	 <p><b>50-0215-99</b></p>	 <p><b>30-0003-99</b></p>	 <p><b>60-0083-99</b></p>
 <p><b>70-1194-52</b></p>	 <p><b>40-0015-52</b></p>	 <p><b>70-2092-99</b></p>	 <p><b>40-0415-99</b></p>	 <p><b>60-0133-99</b></p>

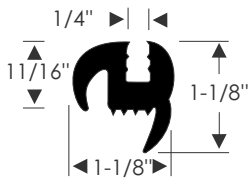

**60-0658-99**

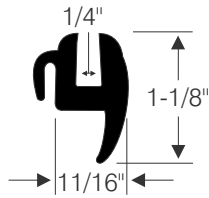

**18-0003-83**

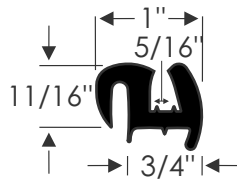

**70-1260-99**

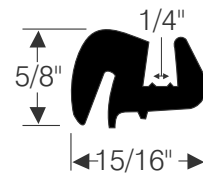

**70-0998-99**

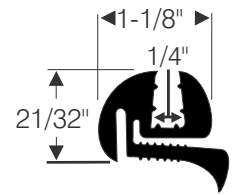

**50-0482-99**

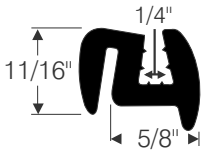

**60-0549-99**

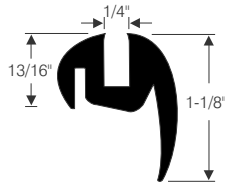

**40-0096-99**

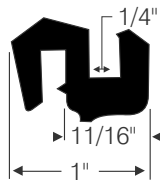

**40-0437-99**

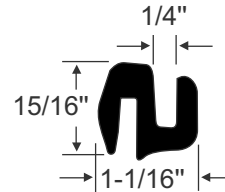

**70-1799-99**

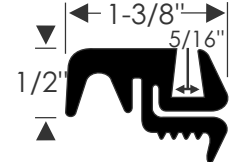

**60-0121-99**



**12-0009-99**

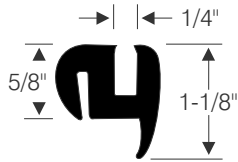

**60-0661-99**

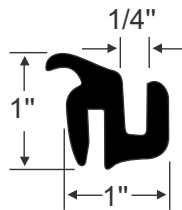

**70-1798-99**

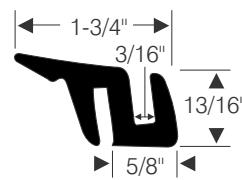

**70-3169-99**

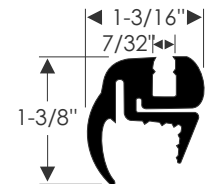

**60-0130-99**



**60-0273-99**

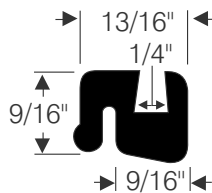

**60-0576-99**

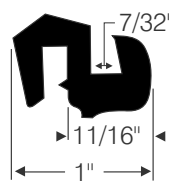

**40-0436-99**

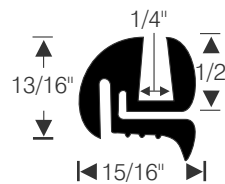

**60-0038-99**

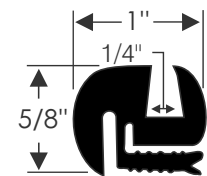

**70-2241-99**

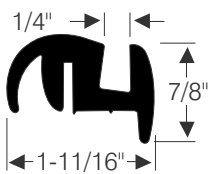

**60-0551-99**

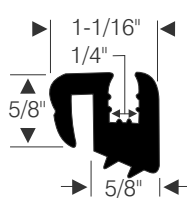

**70-3176-99**

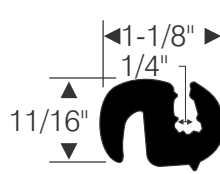

**70-1029-99**

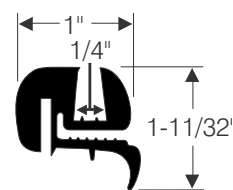

**50-0393-99**

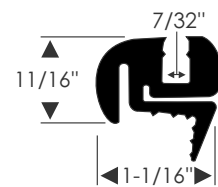

**60-0657-99**

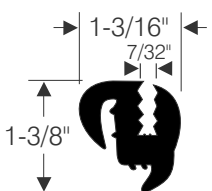

**60-0728-99**

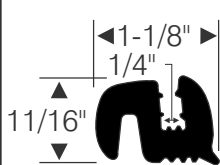

**70-1028-99**

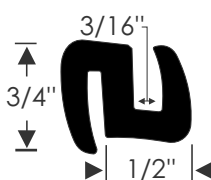

**70-3170-99**

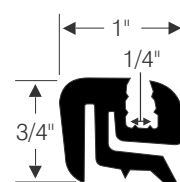

**60-0552-99**

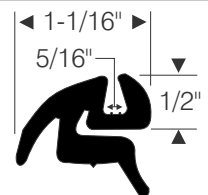

**60-0718-99**

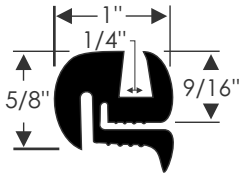

70-2253-99

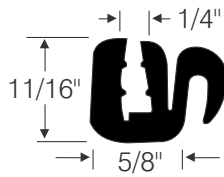

40-0477-99

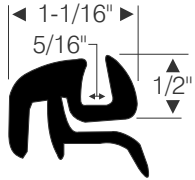

60-0717-99

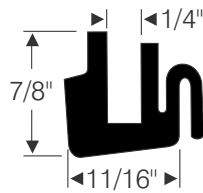

40-0054-99

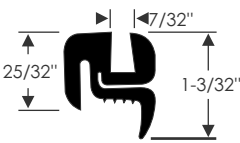

60-0523-99

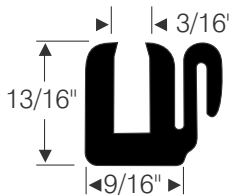

40-0360-99

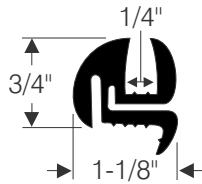

70-1428-99

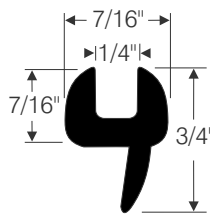

19-0005-99

USES 30-0439-99 LOCKSTRIP  
SEE PAGE 5

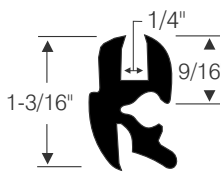

30-0498-99

USES 60-0607-99 LOCKSTRIP  
SEE PAGE 5

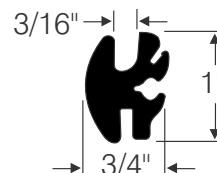

40-0507-99

SELF LOCKING

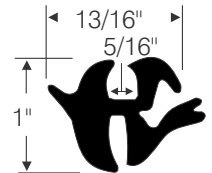

40-0516-99

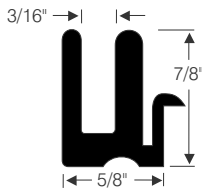

30-0014-99

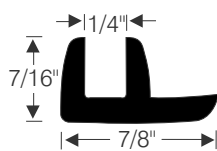

19-0006-99

USES 30-0439-99 LOCKSTRIP  
SEE PAGE 5

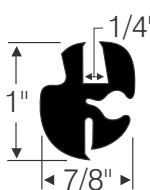

40-0435-99

USES 30-0439-99 LOCKSTRIP  
SEE PAGE 5

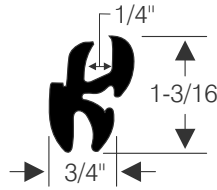

70-1644-99

SELF LOCKING

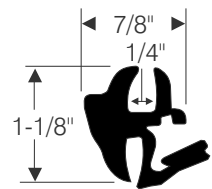

40-0484-99

All of our universal rubber seals on pages 2-13, are sold by the foot. Simply let us know how many feet you require, and we will cut to your custom length.

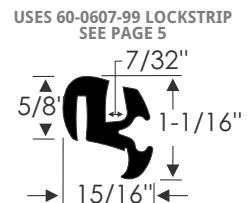

70-1261-99

EXTRUSIONS THAT USE  
**LOCKING STRIPS\***



UNIVERSAL SEAL THAT ACCEPTS LOCKING STRIP (many on this page use a lock strip)

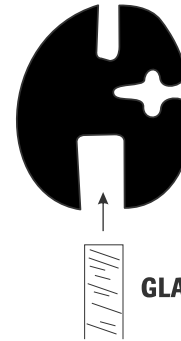

LOCKING STRIP

GLASS



**LOCKING STRIPS**

LOCKING STRIPS can be used with many of the dense rubber seals on this page. Please see Page 5 for a list of locking strips.

\*Typically used on windshield and back window glass on many older cars, trucks and vans.

<p>USES 60-0607-99 LOCKSTRIP SEE PAGE 5</p> <p><b>60-0082-99</b></p>	<p>USES 30-0439-99 LOCKSTRIP SEE PAGE 5</p> <p><b>40-0519-99</b></p>	<p>USES 30-0439-99 LOCKSTRIP SEE PAGE 5</p> <p><b>40-0432-99</b></p>	<p>USES 30-0439-99 LOCKSTRIP SEE PAGE 5</p> <p><b>30-0436-99</b></p>	<p>USES 60-0607-99 LOCKSTRIP SEE PAGE 5</p> <p><b>40-0548-99</b></p>
<p>USES 30-0439-99 LOCKSTRIP SEE PAGE 5</p> <p><b>40-0496-99</b></p>	<p>USES 30-0439-99 LOCKSTRIP SEE PAGE 5</p> <p><b>40-0433-99</b></p>	<p>USES 60-0607-99 LOCKSTRIP SEE PAGE 5</p> <p><b>70-0587-99</b></p>	<p>USES 30-0439-99 LOCKSTRIP SEE PAGE 5</p> <p><b>40-0511-99</b></p>	<p>USES 30-0439-99 LOCKSTRIP SEE PAGE 5</p> <p><b>40-0520-99</b></p>

## LOCKING STRIPS

LOCKING STRIPS can be used with many of the dense rubber seals on pages 4 & 5. They lock the gasket in place for a tight weatherproof seal.

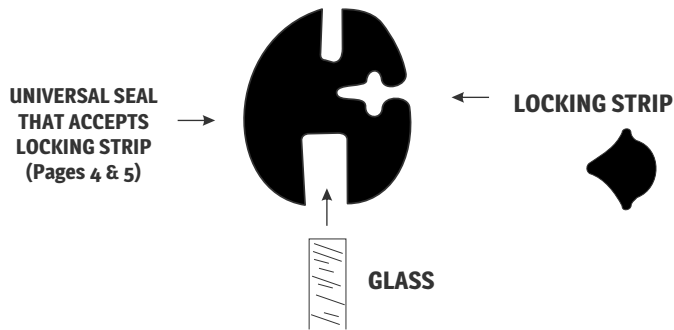

<p><b>60-0607-99</b> Sold per/foot</p>
<p><b>30-0439-99</b> Sold per/foot</p>
<p><b>70-2195-52</b> 16ft. Strip</p>

<p><b>70-1918-52</b> 15ft. Strip</p>
<p><b>70-2196-52</b> 16ft. Strip</p>

<p><b>70-1919-52</b> 15ft. Strip</p>
<p><b>70-3425-52</b> 11ft. Strip</p>

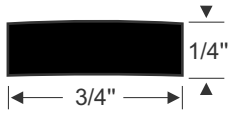

70-2424-99



70-2423-99

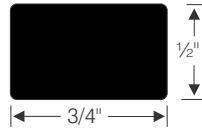

70-2422-99

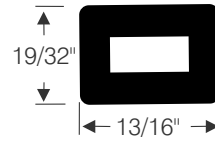

70-2396-99



70-1583-99

# T-RUBBER SEALS

Steele Rubber Product's dense "T-rubber" seals can be used in just about any application where rubber is held in place with a track or channel. Many RV & Marine screen and shower doors utilize T-rubber seals.

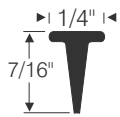

19-0023-73

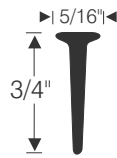

70-0142-52

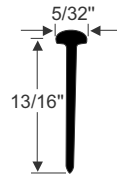

70-3788-99

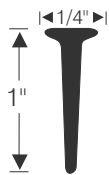

70-1163-52

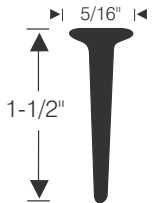

19-0024-52

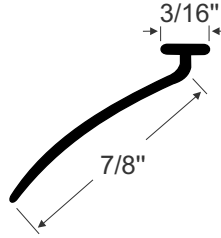

70-3898-99

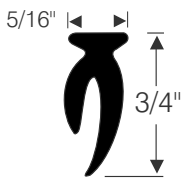

40-0036-99

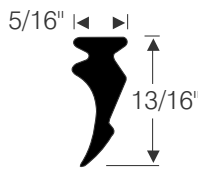

40-0018-99



40-0033-99

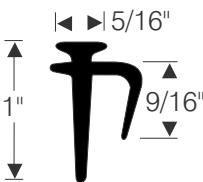

70-0015-99

Metal Track →

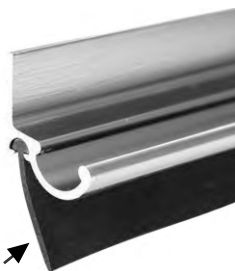

← T-Rubber

# SETTING CHANNEL

The "Setting Channel" extrusions listed below are designed to fold in a "U" shape to hold glass away from a metal frame.

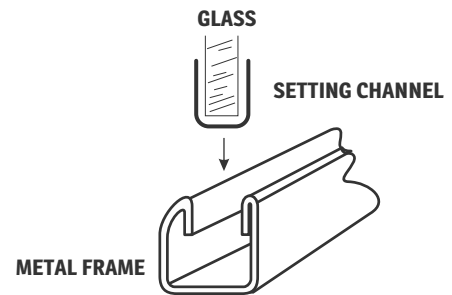

ALL SOLD PER FOOT



SETTING CHANNEL - CORK

70-1114-57

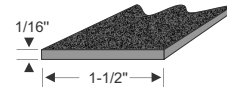

SETTING CHANNEL - CORK

70-1115-57



MOHAIR LINER  
NOT CORK OR RUBBER

70-2863-58

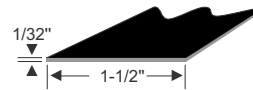

SETTING CHANNEL - RUBBER

70-2169-57

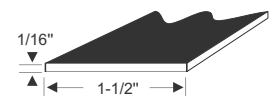

SETTING CHANNEL - RUBBER

70-2170-57

# Universal Seals



<p><b>70-0241-57</b></p>	<p><b>70-0018-99</b></p>	<p><b>70-2093-99</b></p>	<p><b>11-0010-57</b></p>	<p><b>70-0997-99</b></p>
<p><b>70-2324-57</b></p>	<p><b>70-2844-57</b></p>	<p><b>FLOCKED</b> <b>70-1168-58</b></p>	<p><b>40-0095-99</b></p>	<p><b>70-1167-99</b></p>
<p><b>70-2642-57</b></p>	<p><b>70-3827-99</b></p>	<p><b>FLOCKED</b> <b>70-0306-58</b></p>	<p><b>70-0060-65</b></p>	<p><b>60-0566-99</b></p>
<p><b>30-0507-57</b></p>	<p><b>70-0489-58</b></p>	<p><b>FLOCKED</b> <b>70-1169-58</b></p>	<p><b>70-0081-67</b></p>	<p><b>70-0065-73</b></p>
<p><b>30-0154-57</b></p>	<p><b>60-0059-83</b></p>	<p><b>30-0035-65</b></p>	<p><b>19-0004-52</b></p>	<p><b>50-0528-62</b></p>
<p><b>70-1193-99</b></p>	<p><b>70-0075-57</b></p>	<p>Excellent choice for universal glass setting applications.</p> <p><b>70-2860-52 • 15ft.</b></p>	<p>Designed to be used on glass that is flush-mounted with butyl, rivets, etc. May require trimming the stem of the "T" shape to match depth needed.</p>	<p><b>70-2851-52 • 12ft.</b> <b>70-2850-52 • 20ft.</b> <b>70-2841-99 • per/ft.</b></p>

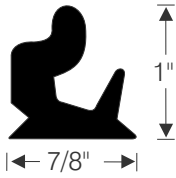

**70-0288-99**

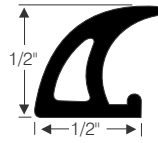

**30-0084-99**

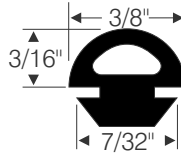

**30-0139-73**



**70-0116-99**

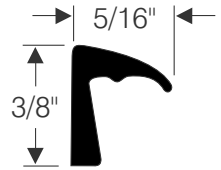

**70-0079-58**

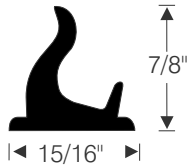

**70-0251-65**

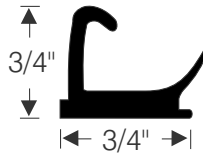

**70-0155-65**

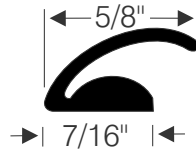

**60-0047-99**

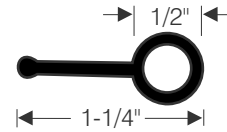

**60-0054-99**

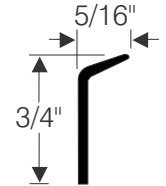

**70-0064-57**

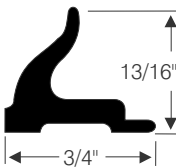

**30-0031-99**

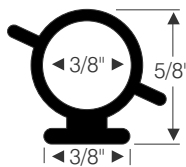

**30-0051-99**

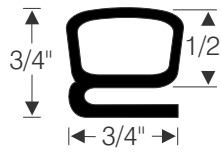

**70-0236-73**

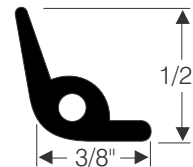

**70-0231-85**

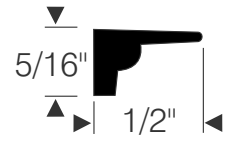

**70-0585-58**

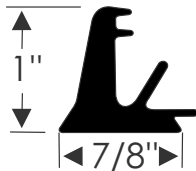

**70-0570-99**



**30-0085-99**

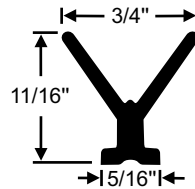

**70-3960-99**



**50-0541-37**

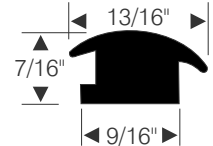

**20-0102-45**

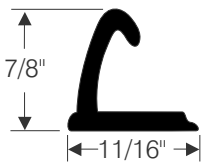

**70-1171-99**

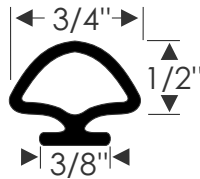

**70-0066-73**

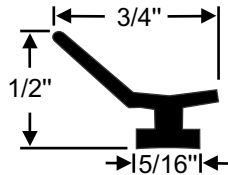

**70-3996-99**

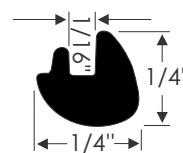

**70-2166-99**

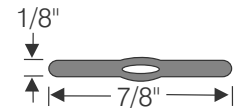

**60-0578-42**

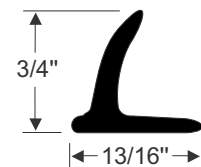

**70-1170-99**

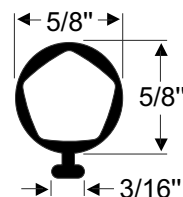

**70-3795-99**

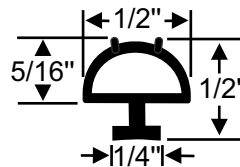

**70-3999-99**

All of our universal rubber seals, on pages 2-13, are sold "by the foot". Simply let us know how many feet you require, and we will cut to your custom length.

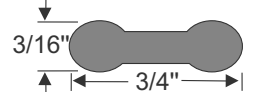

**70-2221-42**

<p><b>70-1446-99</b></p>	<p><b>70-0019-52</b></p>	<p><b>40-0487-73</b></p>	<p><b>70-1448-73</b></p>
<p><b>60-0078-99</b></p>	<p><b>60-0055-52</b></p>	<p><b>70-1237-48</b></p>	<p><b>60-0660-45</b></p>
<p><b>70-0140-99</b></p>	<p><b>70-1236-48</b></p>	<p><b>60-0667-45</b></p>	<p><b>27-0106-30</b></p>
<p><b>40-0475-42</b></p>	<p><b>70-0308-17</b></p>	<p><b>30-0482-41</b></p>	<p><b>70-1292-73</b></p>
<p><b>60-0153-99</b></p>	<p><b>70-1693-57</b></p>	<p><b>60-0287-99</b></p>	<p><b>70-1656-99</b></p>
<p><b>12-0010-99</b></p>	<p><b>70-4064-99</b></p>	<p><b>60-0653-99</b></p>	<p><b>70-3976-99</b></p>



## Quality Crafted Rubber Parts

- Expert Service
- Huge Inventory
- Same Day Shipping
- Manufacturer Direct

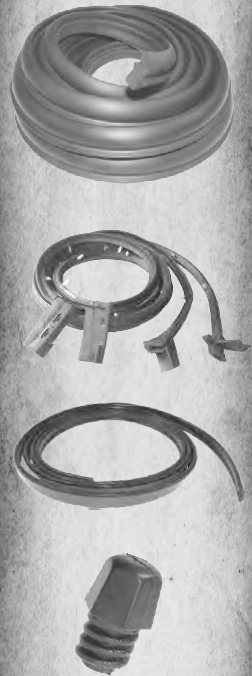

- Molded Parts
- Hood Bumpers
- Roof Rail Seals
- Glass Run Channel
- Lock Pillar Fillers
- Grommets & Plugs
- Vent Window Seals
- Windshield Gaskets
- Hood To Cowl Seals
- Body Mounting Pads
- Door Weatherstripping
- Trunk Weatherstripping

**And Much More!**

# SPONGE RUBBER SEALS

DENSE RUBBER SEALS ON PAGE 2

## How To Order

All of our universal seals, on pages 2-13, are sold "by the foot". Simply let us know how many feet you require, and we will cut to your custom length.



### Possible Uses:

Many of the seals on these pages are perfect for sealing doors and windows.

<p><b>70-1789-99</b></p>	<p><b>70-0492-73</b></p>	<p><b>70-1244-73</b></p>	<p><b>70-0653-99</b></p>	<p><b>70-1269-99</b></p>
<p><b>50-0085-73</b></p>	<p><b>70-0219-73</b></p>	<p><b>70-1111-73</b></p>	<p><b>70-0491-73</b></p>	<p><b>70-2705-99</b></p>
<p><b>70-0145-73</b></p>	<p><b>70-0331-73</b></p>	<p><b>70-1112-73</b> 4" BETWEEN PINS</p>	<p><b>60-0456-99</b></p>	<p><b>60-0411-85</b></p>
<p><b>40-0480-73</b></p>	<p><b>30-0470-99</b></p>	<p><b>70-1045-99</b></p>	<p><b>70-3371-99</b></p>	<p><b>20-1389-99</b></p>
<p><b>70-0390-73</b></p>	<p><b>70-1267-99</b></p>	<p><b>70-1245-73</b> 4" BETWEEN PINS</p>	<p><b>20-2618-99</b></p>	<p><b>60-0562-99</b></p>
<p><b>60-0416-99</b></p>	<p><b>70-0311-73</b></p>	<p><b>70-1731-99</b></p>	<p><b>20-0042-99</b></p>	<p><b>40-0168-73</b></p>

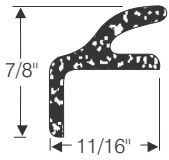

**50-0219-99**

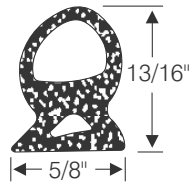

**70-2989-99**

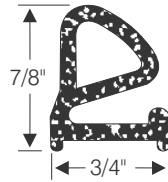

**70-1750-99**

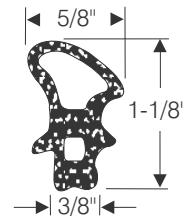

**20-0302-99**

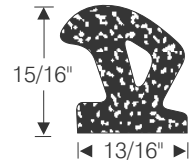

**70-3155-99**

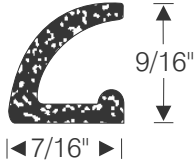

**70-0411-73**

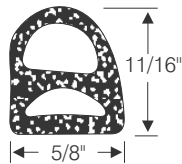

**70-2124-99**

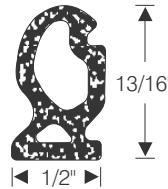

**70-3228-99**

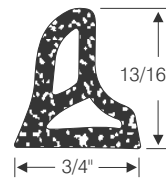

**70-2727-99**

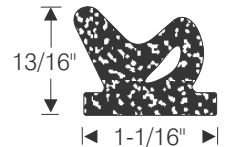

**70-3154-99**

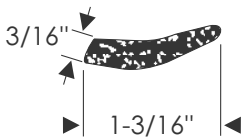

**60-0114-99**

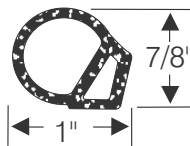

**60-0732-99**

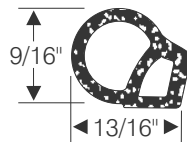

**70-1776-99**

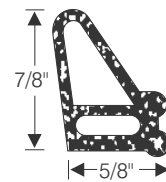

**70-2992-99**

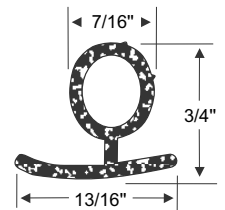

**70-3647-99**

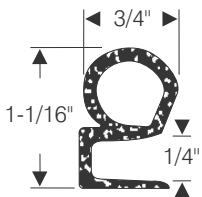

**70-1258-99**

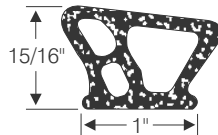

**70-1662-99**

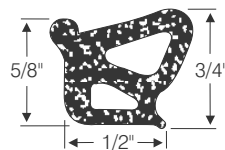

**40-0490-99**

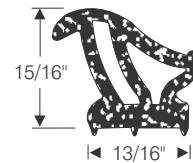

**70-2329-99**

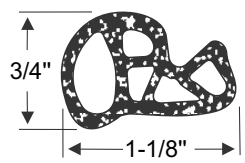

**82-0216-99**

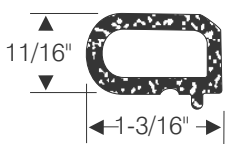

**60-0731-99**

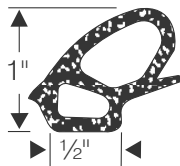

**40-0513-85**

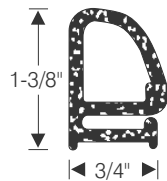

**70-1085-99**

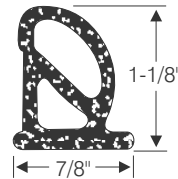

**70-1663-99**



**70-0598-99**

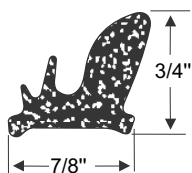

**70-3680-99**

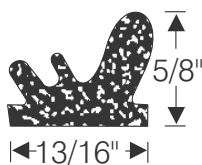

**70-0654-99**



**50-0340-99**



**70-0906-99**

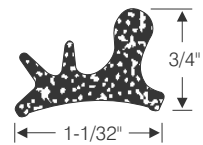

**70-3658-99**



**60-0695-99**



**70-0839-99**

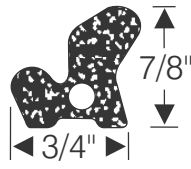

**70-0586-99**



**70-2393-99**

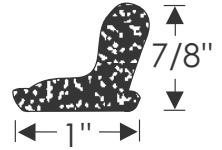

**70-2394-99**

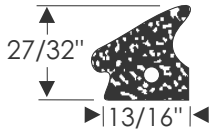

**70-0509-99**

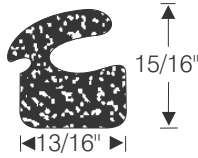

**50-0161-85**

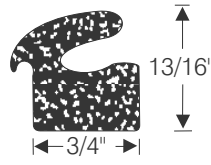

**30-0356-85**

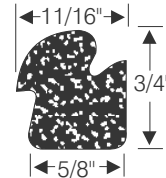

**70-0412-85**

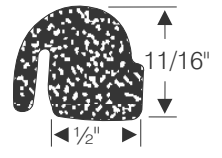

**20-1688-99**

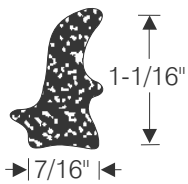

**70-0346-85**

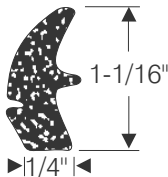

**70-0650-85**

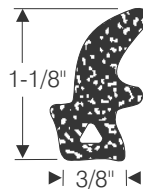

**82-0030-99**

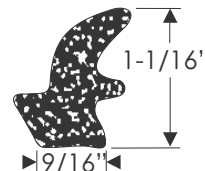

**70-0510-85**

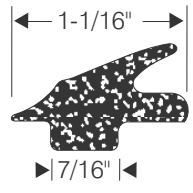

**40-0479-85**

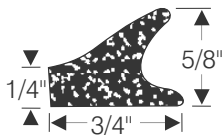

**70-1437-99**

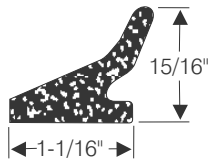

**60-0651-99**

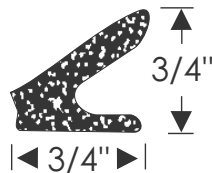

**70-2401-99**



**70-0490-85**

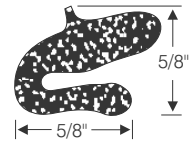

**70-3113-99**

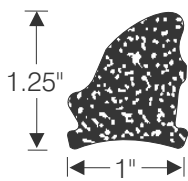

**70-1036-99**

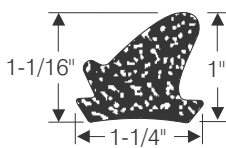

**70-1037-99**



**70-1035-99**

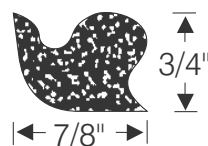

**70-0463-85**

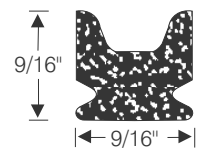

**40-0280-57**

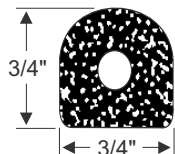

**70-0518-85**



**70-0777-99**



**70-0701-99**

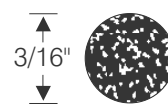

**70-0884-99**

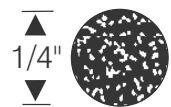

**70-0957-99**

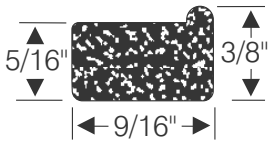

20-0390-99

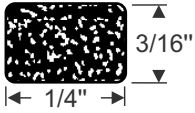

70-3703-99

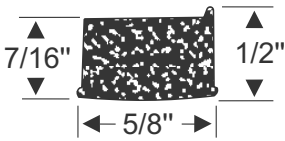

30-0144-87

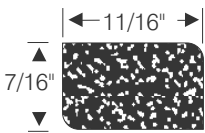

30-0243-73

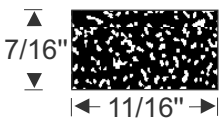

70-1105-99

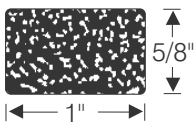

70-0129-99

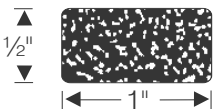

70-1106-99

**WE ALSO OFFER CLASSIC CAR  
& TRUCK WEATHERSTRIPPING**

**CUSTOM CATALOGS  
NOW AVAILABLE!**

Get your completely customized Steele Rubber Products Catalog! You tell us what you're working on and we'll send you a catalog full of parts specifically for that car or truck. Order as many catalogs as you have projects!

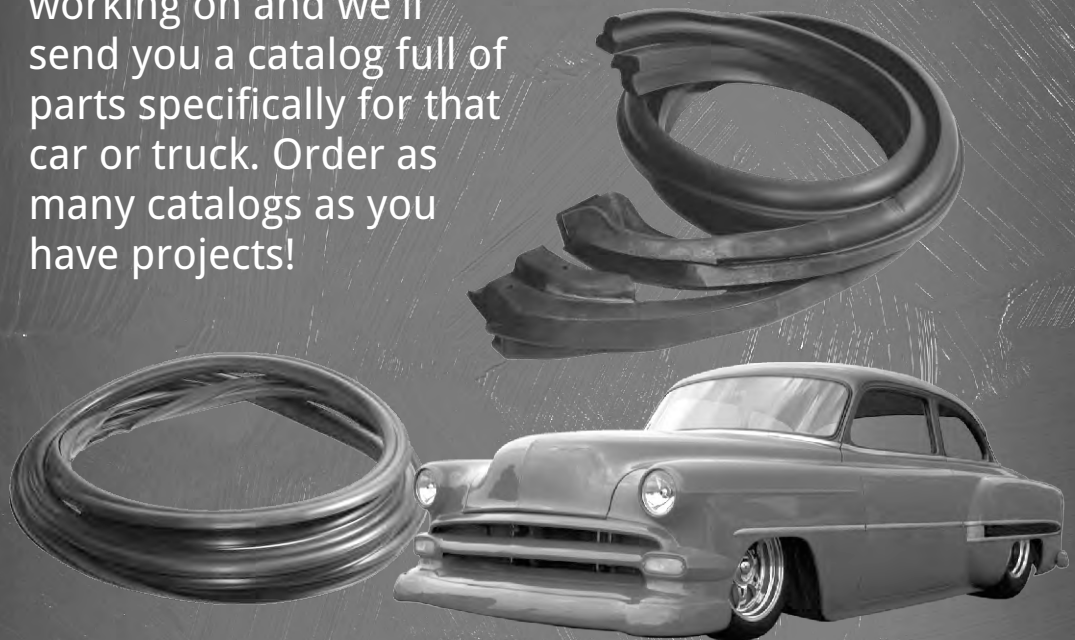

[steelerubber.com/parts](http://steelerubber.com/parts)



SINCE 1958

## EDGING SEALS

These "U-Shaped" Seals can be used for covering rough or dangerous edges. These work great on Metal, Plastic or Fiberglass.

### DENSE RUBBER EDGING

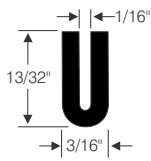

70-3167-33 • 10ft.  
70-3168-33 • 15ft.  
70-3166-99 • per/ft.

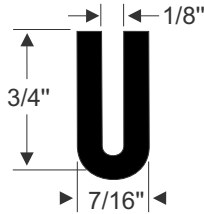

70-3888-99

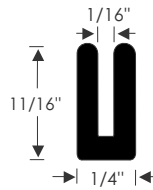

70-0077-99

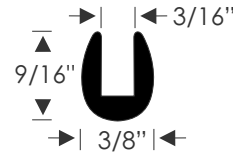

70-3247-44 • 10ft.  
70-3248-44 • 15ft.  
70-3246-99 • per/ft.

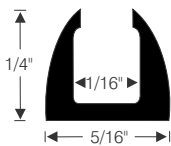

50-0100-99

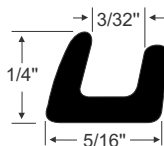

27-0090-14

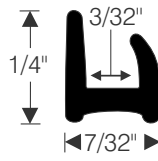

60-0685-99

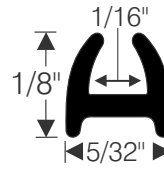

70-0836-99

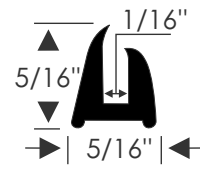

70-2856-99

### SPONGE RUBBER EDGING

70-2119-99 • per/ft.  
83-0120-73 • 10ft.  
83-0121-73 • 15ft.

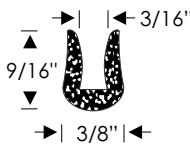

70-2118-99 • per/ft.  
83-0115-73 • 10ft.  
83-0116-73 • 15ft.

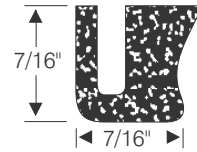
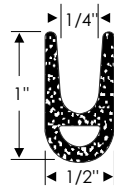

40-0162-99

### EDGING WITH FLEXIBLE METAL CORE

The flexible metal cores can bend to grip edges tightly, providing a simple and safe way to seal.

FOR 1/8" TO 3/16" EDGES

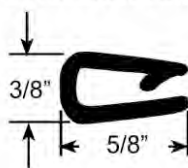

70-3600-99 • per/ft.

FOR 1/32" TO 1/8" EDGES

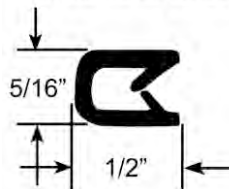

70-3602-99 • per/ft.

FOR 1/8" TO 3/16" EDGES

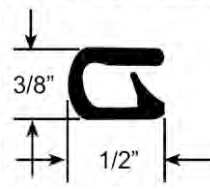

70-3599-99 • per/ft.

FOR 1/8" EDGES

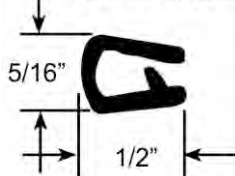

70-3601-99 • per/ft.

FOR 3/16" TO 1/4" EDGES

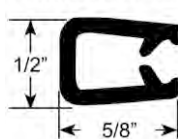

70-3598-99 • per/ft.

FOR 1/32" EDGES

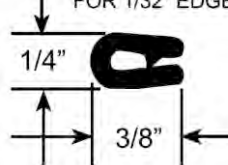

70-3597-99 • per/ft.

FOR 1/32" EDGES



70-3596-99 • per/ft.

## PEEL-N-STICK SEALS

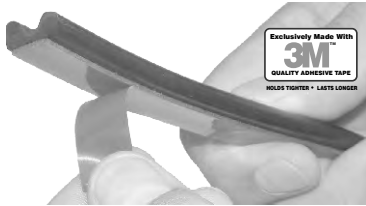

No messy glue, Just peel and stick!

ALL EXTRUSIONS ON THIS PAGE ARE SPONGE RUBBER

Our Peel-N-Stick weatherstripping can be used any place a rubber seal is needed. With easy to use Peel-N-Stick adhesive backing, simply cut to size and fit to the areas you need to seal. Available in multiple lengths and a variety of extrusions, our Peel-N-Stick parts are made of the same quality sponge & dense rubber found in our standard rubber parts and weatherstripping.

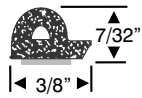

83-0102-73 • 5ft.  
83-0103-73 • 10ft.  
83-0124-73 • 15ft.  
83-1016-73 • 30ft.



83-0109-73 • 5ft.  
83-0110-73 • 10ft.  
83-0111-73 • 15ft.  
83-1020-73 • 30ft.

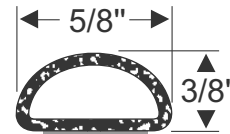

70-3848-99  
per/ft.

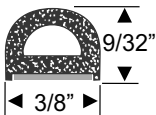

83-0104-73 • 5ft.  
83-0105-73 • 10ft.  
83-0106-73 • 15ft.  
83-1017-73 • 30ft.

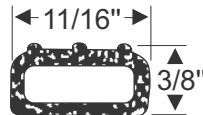

70-3849-99  
per/ft.

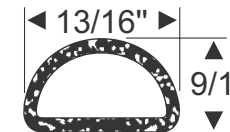

70-3859-99  
per/ft.

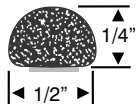

83-0127-73 • 5ft.  
83-0113-73 • 10ft.  
83-0114-73 • 15ft.  
83-1018-73 • 30ft.

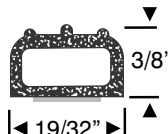

70-3676-99 • per/ft.  
83-1046-73 • 5ft.  
83-1047-73 • 10ft.  
83-1048-73 • 30ft.

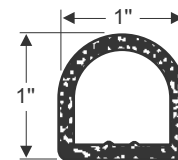

70-3850-99  
per/ft.

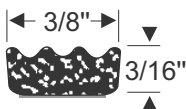

70-3846-99 • per/ft.

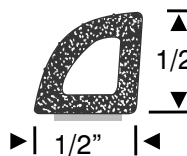

83-0125-73 • 5ft.  
83-0126-73 • 10ft.  
83-0122-73 • 15ft.  
83-1021-73 • 30ft.

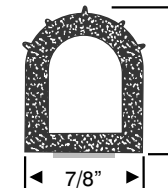

70-3677-99 • per/ft.  
83-1049-73 • 5ft.  
83-1050-73 • 10ft.  
83-1051-73 • 30ft.

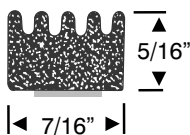

70-3672-99 • per/ft.  
83-1037-73 • 5ft.  
83-1038-73 • 10ft.  
83-1039-73 • 30ft.



83-0128-73 • 5ft.  
83-0129-73 • 10ft.  
83-0119-73 • 15ft.  
83-1022-73 • 30ft.

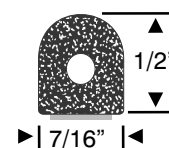

83-0107-73 • 5ft.  
83-0108-73 • 10ft.  
83-0130-73 • 15ft.  
83-1019-73 • 30ft.

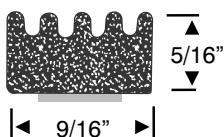

70-3673-99 • per/ft.  
83-1040-73 • 5ft.  
83-1041-73 • 10ft.  
83-1042-73 • 30ft.

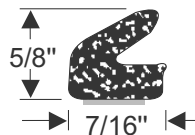

40-0480-73-WT  
per/ft.

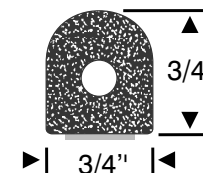

83-1023-85 • 5ft.  
83-1024-85 • 10ft.  
83-1025-85 • 15ft.  
83-1026-85 • 30ft.



70-3858-99 • per/ft.

**PEEL-N-STICK SEALS**

Exclusively Made With  
**3M**<sup>TM</sup>  
QUALITY ADHESIVE TAPE  
HOLDS TIGHTER • LASTS LONGER

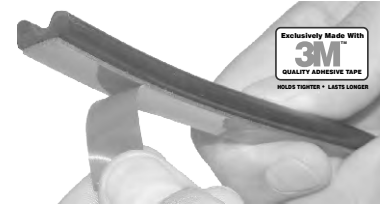

No messy glue, just peel and stick!

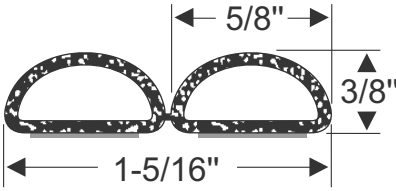

70-4057-99 • per/ft.

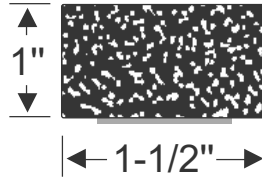

70-3872-99 • per/ft.

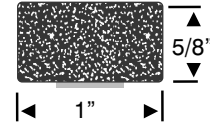

70-0129-99-WT • per/ft.  
83-1031-73 • 10ft.  
83-1032-73 • 30ft.

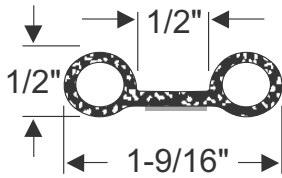

70-3897-99 • per/ft.

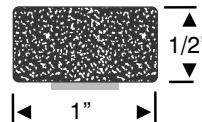

70-1106-99-WT • per/ft.  
83-1035-73 • 10ft.  
83-1036-73 • 30ft.

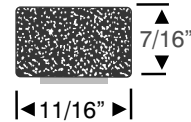

70-1105-99-WT • per/ft.  
83-1033-73 • 10ft.  
83-1034-73 • 30ft.

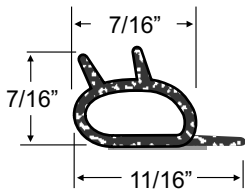

70-3852-99  
per/ft.

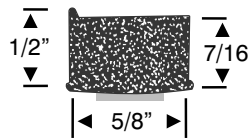

30-0144-87-WT • per/ft.  
83-1027-73 • 10ft.  
83-1028-73 • 30ft.

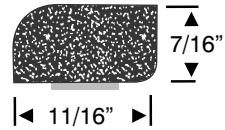

30-0243-73-WT • per/ft.  
83-1029-73 • 10ft.  
83-1030-73 • 30ft.

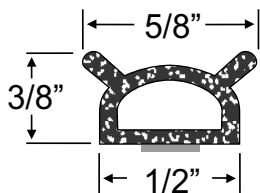

70-3847-99  
per/ft.

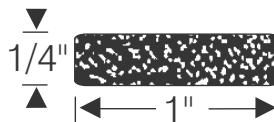

30-0308-99 • per/ft.



70-0519-85 • per/ft.

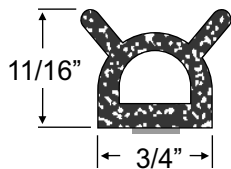

70-3802-99  
per/ft.

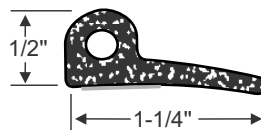



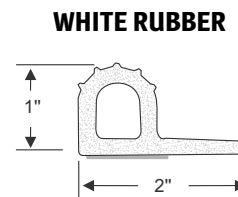

70-3708-99 • per/ft.

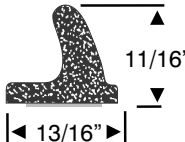
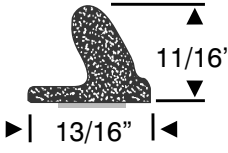

70-3711-99 • per/ft.

## MORE PEEL-N-STICK SEALS

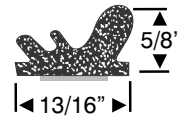
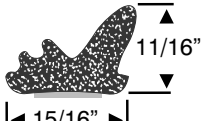
Our Peel-N-Stick weatherstripping can be used any place a rubber seal is needed. With easy to use Peel-N-Stick adhesive backing, simply cut to size and fit to the areas you need to seal. Available in multiple lengths and a variety of extrusions, our Peel-N-Stick parts are made of the same quality sponge & dense rubber found in our standard rubber parts and weatherstripping.

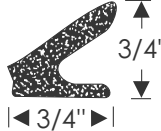
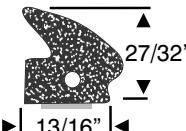
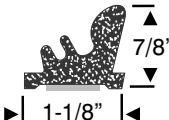
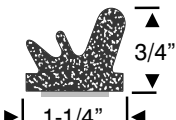
 <p>83-0135-73 10ft.</p>	 <p>83-0131-73 • 5ft. 83-0132-73 • 10ft. 83-0100-73 • 15ft. 83-0118-73 • 30ft.</p>	 <p>83-0134-73 10ft.</p>	 <p>83-0136-73 10ft.</p>	 <p>83-0140-73 10ft.</p>
 <p>83-0137-73 10ft. 70-1437-99-WT per/ft.</p>	 <p>83-0139-73 10ft. 70-2401-99-WT per/ft.</p>	 <p>83-0123-73 10ft.</p>	 <p>83-0133-73 10ft.</p>	 <p>83-0138-73 10ft.</p>



### Weatherstripping & Rubber Parts



**Call today  
for your  
FREE  
Custom Catalog**

Specific to your year/make/model



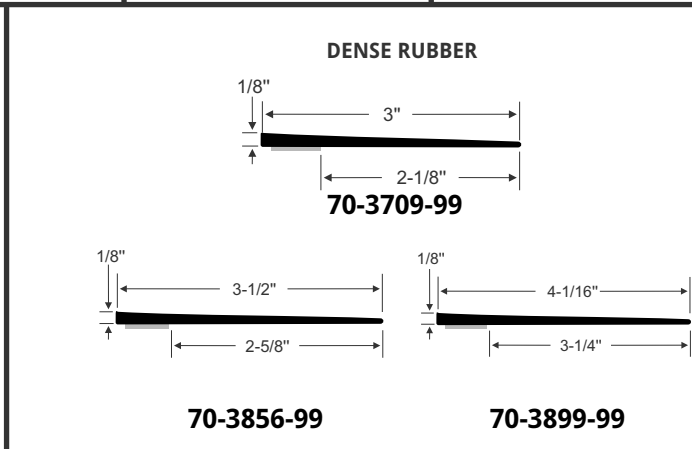

Can be used for a clean looking hood-to-cowl seal that is easy to install.

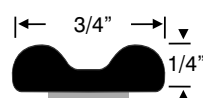

**DENSE RUBBER**  
70-2674-42 • 9ft.  
70-2675-42 • 14ft.

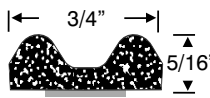

**SPONGE RUBBER**  
70-2684-42 • 9ft.  
70-2685-42 • 14ft.

**PUSH-ON SEALS**

**SIDE CHANNEL BULB**

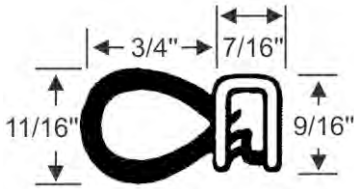

70-3582-99 • per/ft.

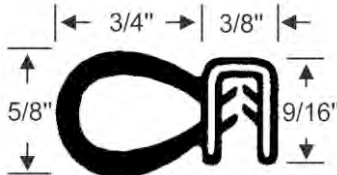

70-3583-99 • per/ft.

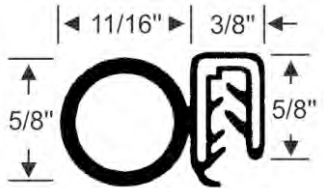

70-3584-99 • per/ft.

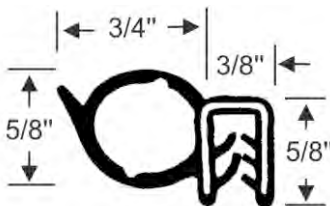

70-3586-99  
25ft. Strip

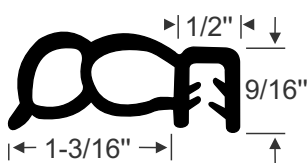

70-3885-99 • per/ft.

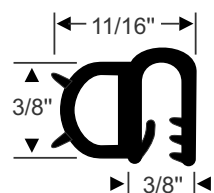

70-3855-99 • per/ft.



70-3594-99  
25ft. Strip



70-3592-99 • per/ft.

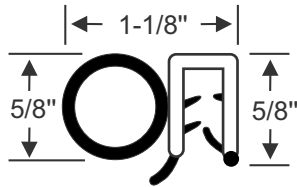

70-3456-99  
25ft. Strip

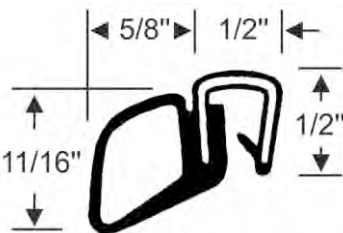

70-3595-99  
25ft. Strip

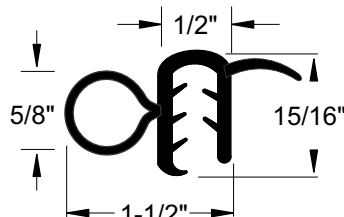

70-2734-99 • per/ft.

The tube shaped bulbs are made of high quality rubber. The flexible metal cores can bend to grip edges tightly, providing a simple and safe way to seal.



**MORE  
PUSH-ON SEALS  
ON PAGE 19.**

**BOTTOM CHANNEL BULB**

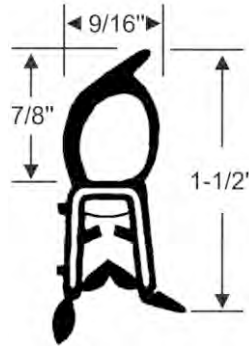

70-3585-99  
25ft. Strip

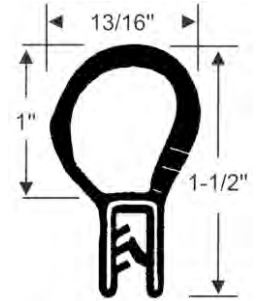

70-3587-99  
25ft. Strip

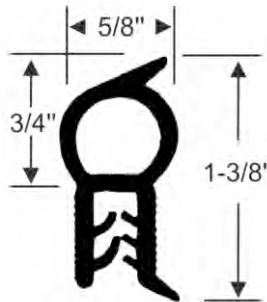

70-3588-99  
25ft. Strip

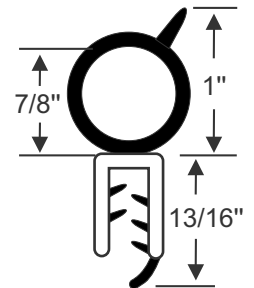

70-2831-99 • per/ft.

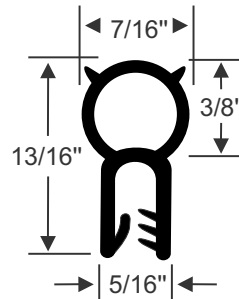

70-3854-99 • per/ft.

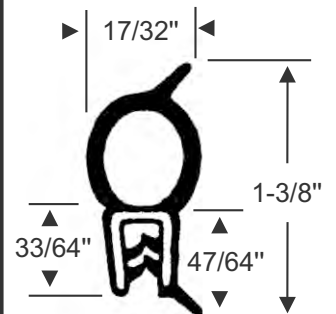

70-3590-99 • per/ft.

## PUSH-ON SEALS

### WITH WIPER

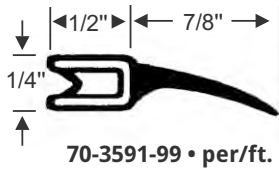

70-3591-99 • per/ft.

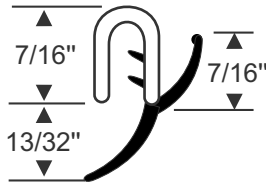

70-2746-99 • per/ft.

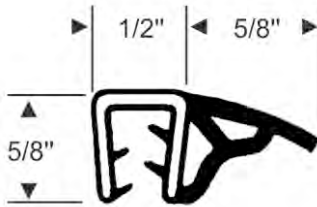

70-3581-99 • per/ft.

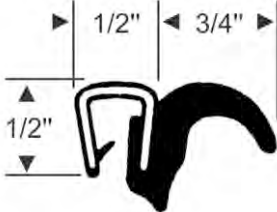

70-3593-99 - 25ft. Strip

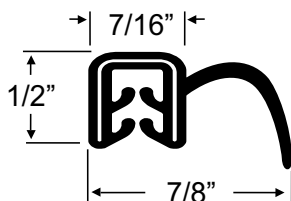

70-3801-99 • per/ft.

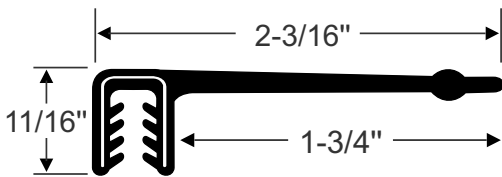

70-3889-99 • per/ft.

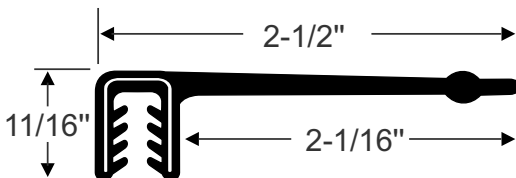

70-3890-99 • per/ft.

## RUN CHANNELS

### WITH METAL SPINE



These Run Channels have a fuzzy lining which creates a smooth surface for glass to slide. They also have a metal spine which makes them tough and durable. The run channels listed here are a perfect choice when restoring antique cars.

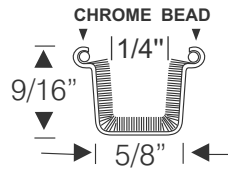

**FLEXIBLE METAL SPINE**  
70-1238-58 - 5' strip  
70-1239-58 - 6' strip

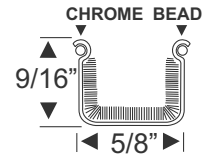

**FLEXIBLE METAL SPINE**  
20-1146-58 - 5' strip

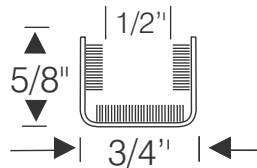

**FLEXIBLE METAL SPINE**  
60-0375-58 - 5' strip  
60-0129-58 - 90" strip

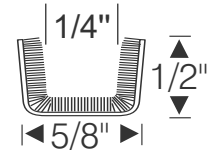

**FLEXIBLE METAL SPINE**  
70-1107-57 - 5' strip  
70-1108-57 - 6' strip

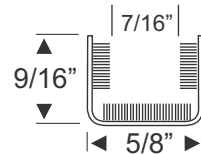

**FLEXIBLE METAL SPINE**  
20-1619-58 - 5' strip  
40-0309-57 - two 3' strips  
40-0309-98 - 8' strip

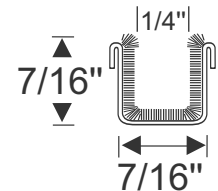

**RIGID METAL SPINE**  
70-0752-58 - 6' strip  
70-3819-58 - two 2' strips

**Steele**  
RUBBER PRODUCTS

CUSTOM CATALOGS AVAILABLE FOR YOUR VEHICLE

[steelerubber.com/catalogs](http://steelerubber.com/catalogs)

**RUN CHANNELS**

**ALL FLEXIBLE  
NO METAL SPINE**

Flexible Run Channels with a flocked lining create a smooth surface for gliding window panels. Works great with glass, acrylic, fiberglass or plastic. These fibers provide low friction, flexibility and long life.

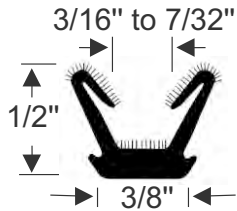

70-3572-58 • 8' strip

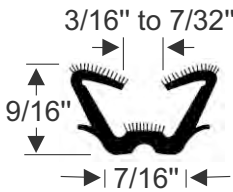

70-3576-58 • 6' Strip

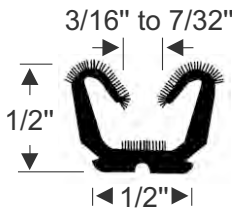

70-3570-58 • 8' strip

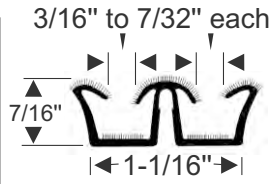

70-3571-58 • 8' strip

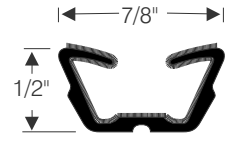

60-0583-58 - 8' strip

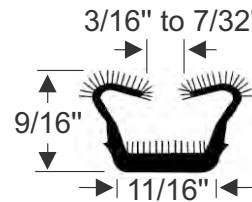

70-3573-58 • 5' Strip

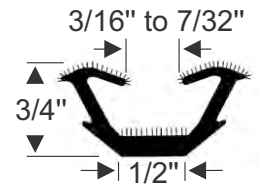

70-3574-58 • 8' strip

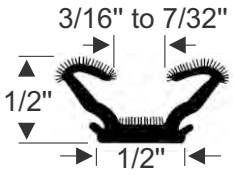

70-3575-58 • 8' strip

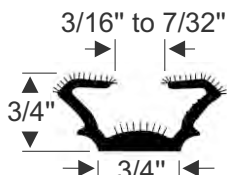

70-3577-58 • 8' strip

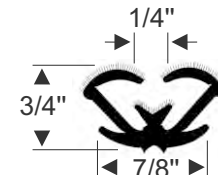

70-3580-58 • 8' strip

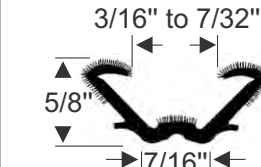

70-3578-58 • 8' strip

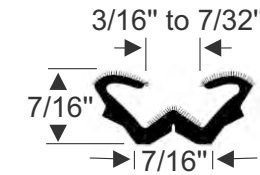

70-3579-58 • 8' strip

**BELTLINE WEATHERSTRIP**

Beltline weatherstrips provide a smooth surface for glass to slide against as it rolls down into the door. They prevent glass from rattling and keep dust and moisture out of the door panel.

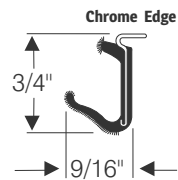

**RIGID METAL SPINE**  
70-0749-60  
two 3' strips  
70-3818-58  
two 2' strips

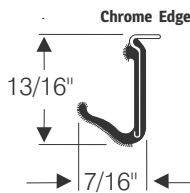

**RIGID METAL SPINE**  
70-0651-58 - 6' strip

**PEEL-N-STICK  
SPONGE RUBBER  
WITH FUZZY  
FLOCKED COATING**

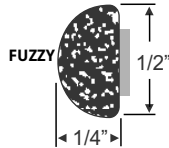

70-2813-60 - 5' strip  
70-2814-60 - 10' strip  
70-2815-60 - 15' strip

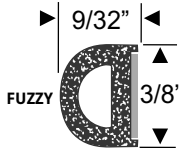

70-4062-99 - per/ft.

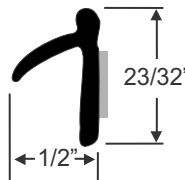

**PEEL-N-STICK  
DENSE RUBBER**  
70-2816-60 - 5' strip  
70-2817-60 - 10' strip  
70-2818-60 - 15' strip

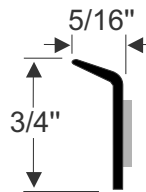

**PEEL-N-STICK  
DENSE RUBBER**  
70-2820-60 - 5' strip  
70-2821-60 - 10' strip  
70-2822-60 - 15' strip

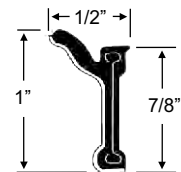

**FLEXIBLE  
METAL SPINE**  
70-3804-61  
two 4' strips

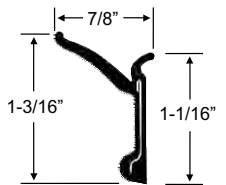

**FLEXIBLE  
METAL SPINE**  
70-3805-61  
two 4' strips

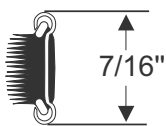

**FLEXIBLE  
METAL SPINE**  
70-0555-58  
two 3' strips  
70-0353-78 - 6' strip

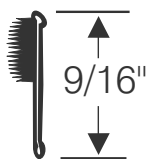

**FLEXIBLE  
METAL SPINE**  
30-0244-57  
two 3' strips

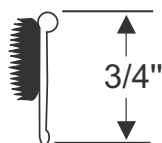

**FLEXIBLE  
METAL SPINE**  
30-0301-57  
two 3' strips  
70-3815-57  
two 2' strips

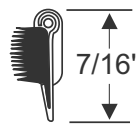

**FLEXIBLE  
METAL SPINE**  
40-0540-57  
6' strip  
40-0539-57  
two 2' strips  
70-3817-57  
two 2' strips

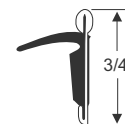

**FLEXIBLE  
METAL SPINE**  
70-1121-61  
two 3' strips  
70-1120-61 - 6' strip

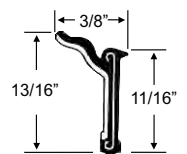

**FLEXIBLE  
METAL SPINE**  
70-3807-61  
two 4' strips

## ROUND GROMMETS

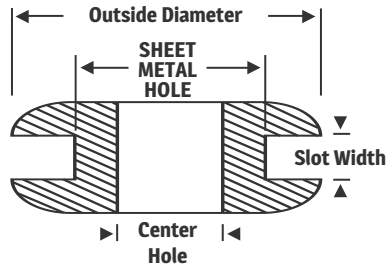

Part Number	Sheet Metal Hole	Center Hole	Outside Diameter	Slot Width
32-1059-20	1/4"	5/32"	3/8"	1/16"
32-1060-20	1/4"	5/32"	7/16"	3/32"
32-1062-20	9/32"	3/16"	3/8"	3/32"
32-1063-20	5/16"	5/32"	7/16"	1/4"
32-1061-20	5/16"	3/16"	1/2"	1/16"
32-0352-20	3/8"	1/4"	9/16"	1/16"
32-0414-32	3/8"	5/32"	9/16"	5/32"
32-1064-20	3/8"	1/4"	1/2"	1/16"
32-1058-20	3/8"	1/8"	1/2"	3/32"
32-0514-20	3/8"	1/4"	5/8"	1/16"
32-0317-52	7/16"	1/4"	3/4"	1/16"
32-0366-53	7/16"	1/8"	5/8"	1/16"
32-1065-20	7/16"	1/4"	5/8"	1/16"
32-0537-24	7/16"	1/4"	3/4"	1/16"
32-1067-20	7/16"	5/16"	9/16"	1/16"
32-0365-20	1/2"	3/16"	3/4"	1/16"
32-0161-21	1/2"	3/8"	11/16"	1/16"
32-0132-67	1/2"	3/8"	13/16"	3/32"
32-1073-20	9/16"	7/16"	3/4"	1/16"
32-1070-20	9/16"	5/16"	13/16"	1/4"
32-0051-24	9/16"	3/8"	5/8"	5/32"
32-0491-21	9/16"	3/8"	15/16"	5/32"
32-1069-20	9/16"	5/16"	3/4"	1/8"
32-0158-17	9/16"	5/16"	13/16"	1/16"
32-1071-20	5/8"	3/8"	7/8"	1/16"
32-1072-20	5/8"	3/8"	7/8"	1/4"
32-0970-17	5/8"	7/32"	13/16"	3/32"
32-0112-20	11/16"	1/4"	1-3/16"	1/16"
32-0047-14	11/16"	3/8"	1"	1/16"
32-0165-15	11/16"	1/8"	15/16"	1/16"
32-0050-24	11/16"	15/32"	3/4"	1/4"
32-0003-21	11/16"	5/16"	1"	1/16"
32-0328-54	11/16"	3/8"	1-3/16"	1/16"
32-1068-20	3/4"	5/16"	1"	1/16"
32-0342-24	3/4"	3/8"	1"	3/16"
32-1075-20	3/4"	1/2"	1"	1/8"
32-0438-20	3/4"	1/2"	1"	3/32"
32-1074-20	3/4"	1/2"	31/32"	3/32"

Part Number	Sheet Metal Hole	Center Hole	Outside Diameter	Slot Width
32-0263-17	3/4"	5/16"	1"	1/16"
32-0066-20	3/4"	1/4"	15/16"	1/16"
32-0162-21	3/4"	1/4"	15/16"	1/16"
32-0064-21	13/16"	1/4"	1"	1/16"
32-1076-20	13/16"	1/2"	1-1/16"	1/4"
32-0002-21	7/8"	13/32"	1-1/16"	1/16"
32-0224-21	7/8"	5/8"	1-1/8"	1/16"
32-1077-20	7/8"	5/8"	1-1/8"	1/8"
32-0057-24	7/8"	5/16"	1-1/4"	1/8"
32-0155-37	7/8"	1/2"	1-5/16"	1/16"
32-0364-37	29/32"	5/8"	1-1/4"	3/32"
32-1078-20	15/16"	3/4"	1-1/8"	1/16"
32-0039-14	15/16"	1/4"	1-1/4"	1/16"
32-0133-21	31/32"	3/4"	1-3/16"	3/16"
32-1066-20	31/32"	1/4"	1-7/32"	1/16"
32-0464-15	1"	3/8"	1-3/8"	1/16"
32-0714-41	1"	3/8"	1-5/16"	1/16"
32-0492-14	1"	11/16"	1-1/4"	1/16"
32-0320-21	1"	7/16"	1-7/16"	1/16"
32-0439-20	1"	7/16"	1-5/16"	1/16"
32-0390-21	1"	3/4"	1-1/4"	1/16"
32-0098-21	1"	1/4"	1-5/16"	1/16"
32-0401-45	1"	3/8"	1-1/4"	1/16"
32-0437-20	1-1/16"	7/16"	1-3/8"	1/16"
32-0253-37	1-1/16"	5/8"	2-1/16"	3/32"
32-0369-20	1-1/16"	3/4"	1-3/8"	1/16"
32-0134-20	1-1/16"	13/16"	1-5/16"	5/32"
32-1201-20	1-3/32"	9/16"	1-9/16"	3/32"
32-0167-52	1-3/32"	7/8"	1-7/16"	1/16"
32-0005-14	1-1/8"	5/8"	1-3/8"	1/16"
32-0001-37	1-1/8"	3/4"	1-9/16"	1/16"
32-0365-37	1-5/32"	5/8"	1-9/16"	3/32"
32-0062-14	1-5/32"	3/4"	1-7/16"	1/16"
32-0355-37	1-1/4"	5/8"	2"	1/16"
32-1079-20	1-1/4"	3/4"	1-5/8"	1/4"
32-0421-37	1-1/4"	3/4"	1-5/8"	1/4"
32-0422-20	1-1/4"	1/2"	1-7/16"	1/4"
32-0220-21	1-1/4"	1/4"	1-1/2"	1/16"
32-0118-37	1-1/4"	3/4"	1-5/8"	1/16"
32-0063-14	1-5/16"	1/2"	1-5/8"	1/16"
32-0455-14	1-5/16"	7/8"	1-5/8"	1/16"
32-0023-14	1-5/16"	1-1/16"	1-7/8"	1/16"
32-0196-21	1-5/16"	5/16"	1-11/16"	1/16"
32-0160-20	1-3/8"	1/2"	1-11/16"	1/8"
32-0062-20	1-3/8"	5/16"	1-7/8"	1/8"
32-0333-20	1-3/8"	7/16"	1-3/4"	3/32"
32-0225-20	1-1/2"	11/16"	2-1/4"	3/32"

## STEM BUMPERS



This is a sample design  
Actual stem bumpers  
may be different.

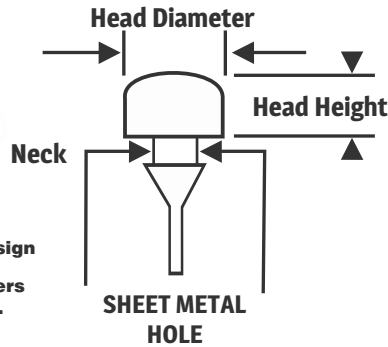

Our stem bumpers can be used to protect a variety of sheet metal applications. Grommets are listed below by the size of the sheet metal hole. Call for assistance. 800-230-5871

**NOTE:** The sheet metal hole size of the neck will be slightly smaller than the actual hole for better sealing.

Part Number	SHEET METAL HOLE	Head Diameter	Head Height	Part Number	SHEET METAL HOLE	Head Diameter	Head Height
33-0730-42	1/8"	3/8"	3/32"	33-0350-87	1/4"	15/16"	3/8"
33-0127-41	1/8"	5/16"	1/8"	33-0427-42	1/4"	5/8"	3/16"
33-0128-88	1/8"	5/16"	1/4"	33-0482-42	1/4"	5/8"	7/16"
33-0556-15	1/8"	1/2"	1/16"	33-0046-42	1/4"	3/4"	5/16"
33-0348-54	3/16"	1/2"	5/8"	33-1574-71	1/4"	5/8"	1/4"
33-0368-30	3/16"	1/2"	7/16"	33-0003-42	1/4"	11/16"	1/8"
33-0507-62	3/16"	7/16"	1/8"	33-0019-20	1/4"	7/16"	3/16"
33-0990-87	3/16"	15/16"	1/2"	33-0449-42	1/4"	1/2"	1/4"
33-0117-42	3/16"	5/8"	5/16"	60-0734-71	1/4"	9/16"	1/4"
33-0349-87	3/16"	1/2"	3/32"	33-1576-71	5/16"	9/16"	1/2"
33-0042-42	3/16"	7/16"	1/2"	33-1575-71	5/16"	5/8"	3/4"
33-0123-42	1/4"	3/4"	1/2"	33-0531-42	5/16"	13/16"	1/4"
33-0512-44	1/4"	3/8"	5/32"	33-0031-42	5/16"	1/2"	1/8"
33-0136-42	1/4"	1/2"	5/16"	33-0109-71	5/16"	3/4"	1/4"
33-0211-31	1/4"	5/8"	1/4"	33-0116-42	5/16"	3/4"	1/2"
33-0293-87	1/4"	7/8"	15/16"	33-0542-42	5/16"	3/4"	5/16"
33-0459-42	1/4"	3/4"	3/16"	33-0113-42	5/16"	3/4"	3/16"
33-0496-71	1/4"	1/2"	3/8"	33-0293-71	5/16"	3/4"	11/16"
33-1285-42	1/4"	9/16"	3/16"	33-0016-45	3/8"	1"	11/32"
33-0395-42	1/4"	9/16"	3/32"	33-0169-42	3/8"	11/16"	3/8"

Stem bumpers come in a variety of shapes. These are examples of different stem bumpers.



Part# 33-0127-41



Part# 33-0348-54



Part# 33-0211-31

## ROUND BODY PLUGS

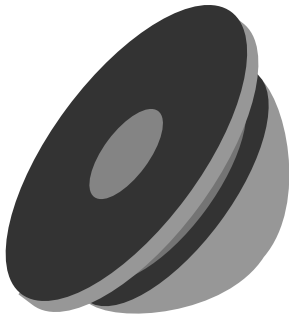

This is a sample design

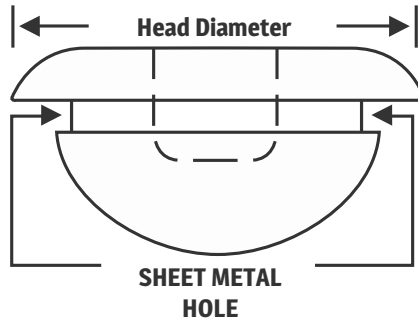

Our body plugs can be used for a variety of sheet metal applications. Body Plugs are listed by the size of the sheet metal hole. Call for assistance. 800-230-5871

**NOTE:** The sheet metal hole size of the plug will be slightly smaller than the actual hole for better sealing.

Part Number	SHEET METAL HOLE	Head Diameter	Material
35-0458-45	3/8"	5/8"	Rubber
35-0369-20	1/2"	3/4"	Rubber
35-0070-87	1/2"	3/4"	Rubber
35-1052-20	1/2"	7/8"	Plastic
35-0171-20	9/16"	13/16"	Rubber
35-0197-31	3/4"	1-1/8"	Rubber
35-0262-20	3/4"	1"	Rubber
35-0515-20	3/4"	1"	Rubber
35-1053-20	3/4"	1-1/8"	Plastic
35-1054-20	3/4"	1-1/8"	Plastic
35-0402-87	7/8"	1-1/8"	Rubber
35-0099-20	15/16"	1-3/16"	Rubber
35-1214-20	1"	1-5/16"	Rubber
35-0457-45	1"	1-3/8"	Rubber
35-1055-20	1"	1-3/8"	Plastic
35-0327-45	1-1/8"	1-1/2"	Rubber
35-1056-20	1-1/4"	1-5/8"	Plastic
35-0517-45	1-3/8"	1-5/8"	Rubber
35-3508-45	2"	2-7/16"	Rubber

Body plugs come in a variety of sizes. These are examples of our body plugs



Part# 32-0456-20



Part# 35-0369-20



Part# 35-1214-20

## Complete selection of weatherstripping for RV's and Enclosed Trailers!

Visit [rv.steelerubber.com](http://rv.steelerubber.com) for many more extrusions!



### SLIDE OUT SEALS



Many more RV weatherstripping seals available!!!

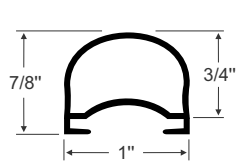
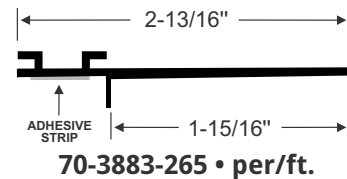

70-3882-265 • per/ft.

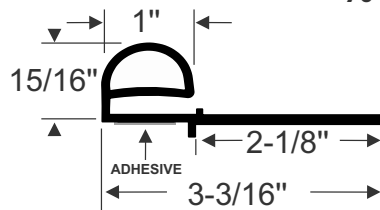

70-3800-265 • per/ft.

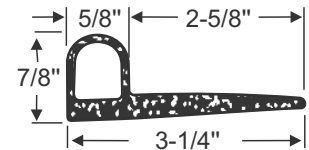

70-3712-265 • per/ft.

### DOOR & COMPARTMENT

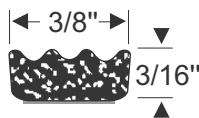

70-3846-277 • per/ft.

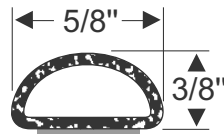

70-3848-277 • per/ft.

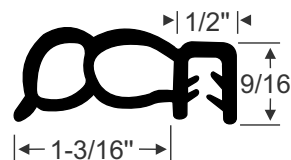

70-3885-277 • per/ft.

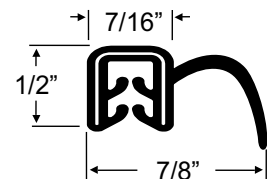

70-3801-277 • per/ft.

### ROOF TOP AC/HEAT PUMP 1 PC. GASKET

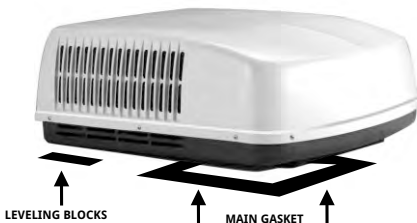

70-3905-207 • set

Unique 1 pc. design!

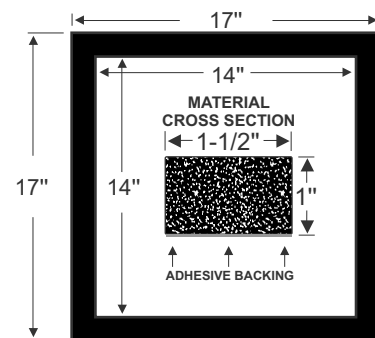

### RAMP GATE KITS



Our ramp gate kits come with everything you need! Peel-N-Stick extrusion, corner pads, glue for splicing, tuck tool & instructions! Call one of our Product Specialists today!

Small kit - 20ft. 90-3326-283

Med. kit - 25ft. 90-3327-283

Large kit - 30ft. 90-3328-283

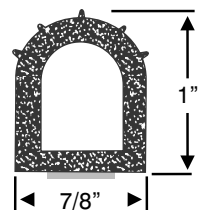

Many more RV weatherstripping seals available . . .

Visit [rv.steelerubber.com](http://rv.steelerubber.com) today!



## NEW from Steele Rubber . . . Marine Weatherstripping!

These are just a few of our marine products.  
Visit [marine.steelerubber.com](http://marine.steelerubber.com) today.

### RUB RAIL INSERT KITS

More Profiles Available

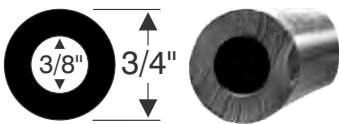

70-3976-347 - per/ft.  
70-3992-347 - 50ft.  
70-3993-347 - 70ft.

STEELE RUBBER PRODUCTS  
RUB RAIL INSERT

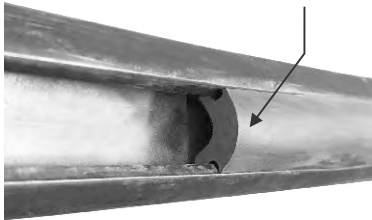

↑ COMMON RUB RAIL

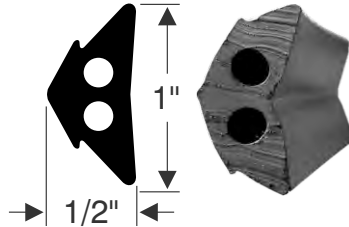

90-3331-347 - 50ft.  
90-3332-347 - 70ft.  
90-3333-347 - 200ft.

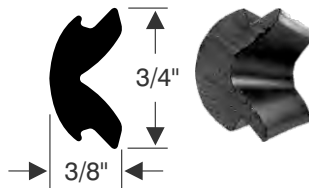

90-3338-347 - 50ft.

### HATCH SEALS



70-0519-372 • per/ft.

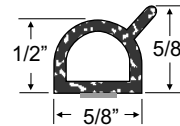

70-3984-377 • per/ft.

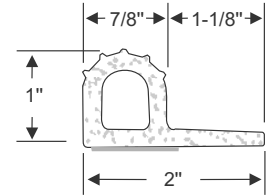

70-3711-377 • per/ft.

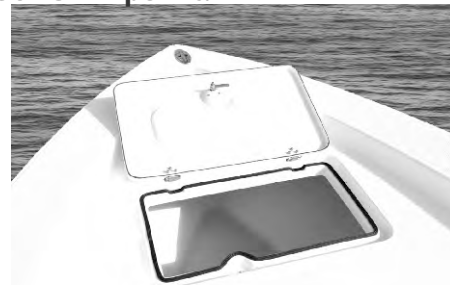

Many More Hatch Seal Profiles Available

### WINDSHIELD GLASS TRIM

EXAMPLE OF WINDSHIELD  
GLASS TRIM

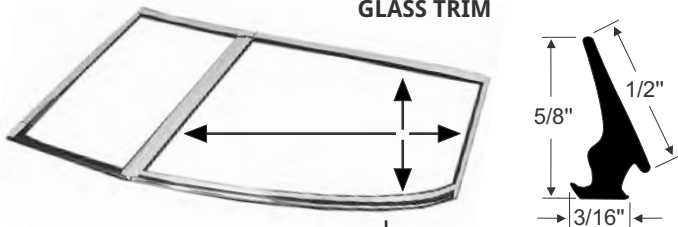

70-3794-357 • per/ft.

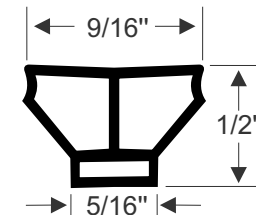

70-3813-340 • per/ft.



FITS IN BOAT WINDSHIELD  
FRAMES TO HIDE  
MOUNTING HARDWARE



70-3825-355 • per/ft.

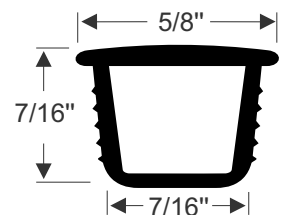

70-3824-355 • per/ft.

Many more Marine weatherstripping seals available . . .

Visit [marine.steelerubber.com](http://marine.steelerubber.com) today!

**UNIVERSAL PARTS**

This page contains parts that can be used for a variety of uses.

**Dimmer Switch Grommet**

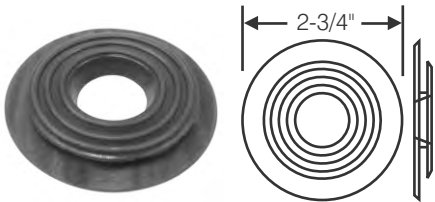

Dimmer switch grommet for automobiles. Has a wide flange for 1" hole for carpet application. 2-3/4" inches overall.  
**40-0083-88**

**Rubber Sheeting**



Please order rubber sheeting by the square foot as shown here.

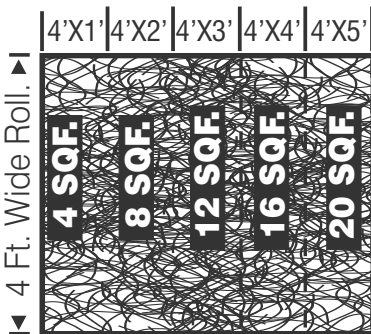

Rubber masticated sheet. 3/32" thick rubber sheet containing random milled cotton cord reinforcement. Perfect for front end automobile splash aprons. Many other uses as well. This product is four (4) foot high, and will only be sold in four (4) foot multiples (4' x 1', 4' x 2', 4' x 3', etc...). Please order by the square foot. **70-0645-45**

**Fender Welting for Automobiles**

Fender welting. Superior quality, proper construction of reinforced black vinyl over vinyl core. 1-3/8" inch wide. One fourth (1/4" Or 3/16" bead, 25' or 50' roll. Typically used to attach fenders to automobile body.



**BLACK**



**CHROME**

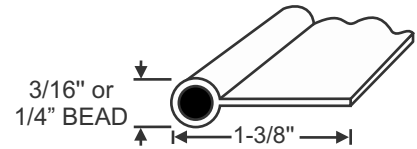

- 70-1097-44** - 1/4" bead, 25' roll.
- 70-1098-44** - 1/4" bead, 50' roll.
- 70-1099-44** - 3/16" bead, 25' roll.
- 70-1100-44** - 3/16" bead, 50' roll.
- 70-1101-44** - CHROME, 3/16" bead, 25' roll.
- 70-1102-44** - CHROME, 3/16" bead, 50' roll.

**Push Button Lock Knobs**

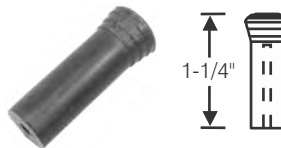

Knob or push button for inside door lock, fits over 1/8" steel rod to door lock. Hard brown rubber, may be lacquered other colors as required. OEM for many GM cars but can be used for other vehicles.  
**70-0660-70**



Knob or push button for inside door lock, fits over 1/8" steel rod to door lock. Neutral brown rubber. OEM for many GM cars but can be used for other vehicles.  
**70-0354-70**

**Battery Terminal Cover**

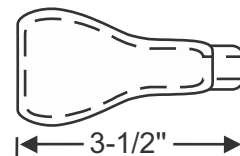

Cover, battery clamp. Control unsightly sulfate buildup. Can be used on most any vehicle battery.  
**70-0095-21**

## Round Rubber Bushings

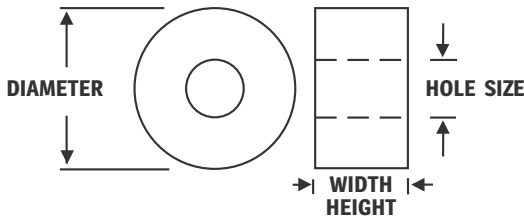

Listed by hole size

	DIAMETER	WIDTH HEIGHT	HOLE SIZE
60-0232-11	2"	13/16"	3/8"
60-0235-33	1"	11/16"	3/8"
50-0133-48	1-5/16"	3/8"	7/16"
50-0132-48	1-3/4"	5/16"	7/16"
60-0231-11	1-7/16"	7/8"	7/16"
60-0216-33	1-1/4"	3/4"	7/16"
70-1125-33	1-1/8"	1/4"	1/2"
70-1968-36	1-1/4"	5/8"	1/2"
11-0016-33	1-5/16"	11/16"	1/2"
70-0265-48	1-1/2"	1-1/4"	1/2"
70-0264-48	1-7/16"	1/4"	9/16"
70-1967-33	1-7/16"	7/8"	5/8"
11-0019-35	1-7/16"	1-1/8"	5/8"
70-2233-48	1-7/8"	9/16"	5/8"
10-0134-32	7/8"	1/4"	5/8"
50-0229-11	2-3/16"	1/2"	5/8"
60-0463-11	2-1/2"	1-1/4"	3/4"
11-0020-35	1-9/16"	1-1/8"	3/4"
50-0329-48	1-15/16"	3/4"	3/4"
50-0097-48	1-15/16"	1/2"	3/4"
50-0507-48	1-15/16"	13/16"	7/8"
60-0189-48	1-13/16"	9/16"	7/8"
70-2232-48	1-7/8"	9/16"	15/16"



## Possible Uses:

Our rubber bushings and rubber pads can be used anywhere a cushion barrier is needed. Our Square/Rectangle pads are perfect for use as body mounting pads when restoring automobiles.

## Square/Rectangle Rubber Pads

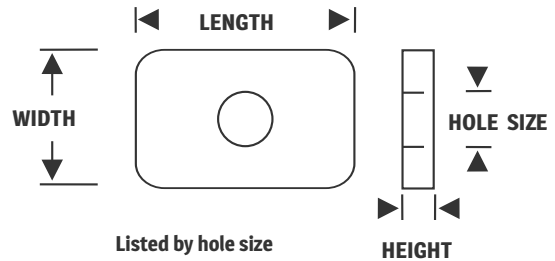

Listed by hole size

	LENGTH	WIDTH	HEIGHT	HOLE SIZE
50-0233-48	2-7/16"	1-11/16"	3/8"	1/2"
50-0231-48	3"	1-11/16"	3/8"	1/2"
50-0232-48	1-15/16"	1-15/16"	3/8"	1/2"
50-0328-48	2-1/16"	2-1/16"	7/16"	5/8"
70-2234-48	2-3/16"	2-3/16"	1/2"	3/4"
70-0634-48	3-3/16"	2-1/8"	7/16"	13/16"

WE ALSO OFFER  
**Quality Crafted Rubber Parts & Weatherstripping**

BUICK - OLDSMOBILE - PONTIAC - CHEVROLET - CADILLAC  
 GMC TRUCK - FORD - LINCOLN - MERCURY - CHRYSLER  
 PLYMOUTH - DODGE - DESOTO - AMERICAN INDEPENDENTS

"ASK ABOUT A CUSTOM CATALOG  
 SPECIFIC FOR YOUR CAR OR TRUCK"

SINCE 1958



### Loctite Super Bonder 495

General purpose instant adhesive designed to bond rubber, metal, and plastic parts. Excellent for modified gaskets or rubber footage made of dense or sponge rubber.

**96-0495-96 (3 gm. Tube)**



### 3M Super Weatherstrip Adhesive (Yellow) \*

Designed specifically to bond rubber gaskets and weatherstripping to metal surfaces. This flexible, high-strength adhesive helps ensure a tight waterproof seal on car doors, trunks, roof rails and more. It cures fast and works right out of the tube, holding rubber weatherstripping in place and resisting heat, vibration, oils and detergents. Yellow in color.

**96-8001-96 (5 oz. Tube)**



### 3M Super Weatherstrip Adhesive (Black) \*

Designed specifically to bond rubber gaskets and weatherstripping to metal surfaces. This flexible, high-strength adhesive helps ensure a tight waterproof seal on car doors, trunks, roof rails and more. It cures fast and works right out of the tube, holding rubber weatherstripping in place and resisting heat, vibration, oils and detergents. Black in color.

**96-8008-96 (5 oz. Tube)**



### 3M Weatherstrip Adhesive (Black) \*

For bonding trim fabrics (except vinyl), trunk linings, floor mats, rugs, silencer pads and KB boards. Also used as a good general purpose rubber cement. Had quick tack, will not bleed through fabric.

**96-8011-96 (5 oz. Tube)**



### 3M Plastic and Emblem Adhesive

An excellent clear adhesive for plastic repair and emblem application. Use this strong, quick-drying adhesive for plastic or metal emblems, interior rigid plastic, tail light lenses, vinyl side moldings or upholstery.

**96-8061-96 (5 oz. Tube)**

### 3M General Purpose Liquid Adhesive Cleaner \*

A specially blended solvent that provides easy clean up of most types of adhesives and quickly removes waxes, road tars, grease, oil and similar materials. Will not harm thoroughly dried automotive paint, vinyl or fabrics when properly used.

**CANNOT BE SHIPPED VIA AIR**

**96-8984-96 (Quart Can)**



### \*State of California Only WARNING:

Products with an asterisk (\*) can expose you to chemicals including toluene which is known to the State of California to cause cancer or birth defects or other reproductive harm. For more information, visit [www.P65Warnings.ca.gov](http://www.P65Warnings.ca.gov)

### 3M General Purpose Adhesive Cleaner - Spray \*

Quickly cleans off wax, grease, oil, old adhesive, road tar, silicone, etc. Will not dissolve or mar automotive paint that has been properly aged. Also suitable for use on vinyl or glass surfaces.

**CANNOT BE SHIPPED VIA AIR**

**96-8987-96 (15 oz. Aerosol)**



### 3M Urethane Adhesive \*

Auto Glass Urethane Windshield Adhesive is a medium viscosity, one-part, moisture-curing urethane adhesive. It is formulated to be fast-curing and non-sagging for rapid results and a clean and simple application process. The features of this windshield adhesive produce high-strength material designed to bond and seal vehicle windshields, backlights and sidelights.

**96-8693-96 (10.5 oz. Cartridge)**



### 3M Rubberized Undercoating \*

Professional Grade Rubberized Undercoating produces a textured finish which resists chipping, abrasion, exterior rusting and weathering. This coating provides one-coat build-up with no dripping, running or sagging. The undercoating is excellent for automotive undercarriages and for other uses including protection for wheel wells, fenders, quarter panels and more.

**CANNOT BE SHIPPED VIA AIR**

**96-3584-96 (16 oz. Aerosol)**



### 3M Auto Bedding and Glazing Compound

Flexible sealer designed specifically for creating a watertight seal between windshield rubber gaskets and auto bodies. This synthetic rubber-based sealer remains permanently soft, making it suitable as a bedding and a supplementary adhesive sealer for auto glass. It also resists sagging for use in vertical and overhead auto seals.

**96-8509-96 (10 oz. Cartridge)**





**Clip & Retainer Removal Tool** For removing clips and retainers quickly and easily. Simply seat the tool on the shaft of the fastener and squeeze the handles together. Made of high carbon steel and heat treated for strength. Zinc plated with vinyl molded handle grips.

**94-0100-94**



**All Purpose Tool - Short Tip** A varied-purpose tool. Assists in the installation of roof, windows, windshield rubber and back glass. Used to remove body clips, moldings, springs, cotter pins and radiator hoses. Measures 9.5 inches long by 5.5 inch blade.

**94-0101-94**



**All Purpose Tool - Longer Tip** An all-purpose tool with an extra long hook. Use to remove moldings, body clips, windshield seals, cotter pins, and radiator hoses. Made of tough spring steel, heat treated, tempered, and plated. 8 inches long, 4.875 inch blade with 2 inch hook.

**94-0102-94**



**Wooden Handled Tucking Tool** For tucking, headlining, and upholstery around windows, above doors and other hard to reach places. A sturdy, rough tool with a slightly curved blade that has finished edges around corners. Comfortable wood handle. 7.5 inches long by 2.625 inch blade.

**94-0104-94**

## Locking Strip Tools



This tool helps install the 3/8" locking strip used on the windshield and rear window of some cars.

**94-0108-94**



This tool helps install the 3/8" locking strip used on the windshield and rear window of GM and Chrysler cars.

**94-0111-94**



This tool helps install the 5/8" locking strip used on the windshield and rear window of Chrysler cars.

**94-0113-94**



## Heavy Duty Glass Retainer Clip Tool

Reduces the risk of chips and scratches to glass windows caused by makeshift tools. This tool is specifically designed to fit trim clips over the studs and virtually eliminates glass breakage. It also dispenses with the need to remove rubber-like sealant surrounding the studs. A practical tool for placing trim retainer clips over headed studs welded around the body window shields and rear window openings.

**94-0106-94**



## Ferrule Installing Tool

Installing tool, door and trunk handle ferrule. For cars and trucks using door and trunk handle ferrules such as our #70-0111-69.

**70-0662-69**



## GM Type Trim Pad Removing Tool

Specifically designed to pull out plastic trim pad fasteners used on GM cars. It reaches under the trim panel, supports and grips the plastic fasteners, and lifts it without damage to the fastener or to the trim pad backboard. This tool is made of heat treated, high carbon steel and will work equally on metal fasteners. 8.5 inches long.

**94-0107-94**



## Trim Pad & Glued In Windshield Molding Removal Tool

For auto trim work. Double ended tool combines both left and right hand. Removes reveal molding on rubberless windshield jobs. 9.5 inches long.

**94-0108-94**



## Scraper/Tuck Tool

This handy tool makes replacing windshield gaskets a little easier. A good multi purpose tool too. 8"X11/16"

**94-0110-00**



## Steele Branded Safety Glasses

Reinforced plastic, clear lenses, and wraparound frame.

**94-0109-94**

## 2019 PRICING

10-0134-32 \$4.70/ea.	32-0155-37 \$4.00/ea.	33-0117-42 \$4.60/ea.	40-0487-73 \$6.20/ft.	60-0685-99 \$3.90/ft.
11-0010-57 \$5.40/ft.	32-0158-17 \$0.70/ea.	33-0123-42 \$2.60/ea.	40-0490-99 \$5.80/ft.	60-0687-99 \$6.40/ft.
11-0016-33 \$11.80/ea.	32-0160-20 \$12.10/ea.	33-0127-41 \$1.30/ea.	40-0496-99 \$6.99/ft.	60-0695-99 \$6.20/ft.
11-0019-35 \$17.50/ea.	32-0161-21 \$4.80/ea.	33-0128-88 \$1.00/ea.	40-0507-99 \$6.20/ft.	60-0717-99 \$6.90/ft.
11-0020-35 \$17.50/ea.	32-0162-21 \$3.50/ea.	33-0136-42 \$2.50/ea.	40-0511-99 \$6.20/ft.	60-0718-99 \$7.80/ft.
12-0009-99 \$5.30/ft.	32-0165-15 \$4.50/ea.	33-0169-42 \$3.50/ea.	40-0513-85 \$5.40/ft.	60-0728-99 \$7.80/ft.
12-0010-99 \$7.80/ft.	32-0167-52 \$4.30/ea.	33-0211-31 \$4.50/ea.	40-0516-99 \$8.40/ft.	60-0731-99 \$6.60/ft.
18-0003-83 \$5.70/ft.	32-0196-21 \$15.50/ea.	33-0293-71 \$4.80/ea.	40-0519-99 \$6.60/ft.	60-0732-99 \$6.40/ft.
18-0004-77 \$7.20/ft.	32-0220-21 \$6.10/ea.	33-0293-87 \$2.80/ea.	40-0520-99 \$7.30/ft.	60-0734-71 \$0.90/ea.
19-0004-52 \$7.30/ft.	32-0224-21 \$1.00/ea.	33-0348-54 \$2.50/ea.	40-0548-99 \$6.49/ft.	70-0015-99 \$5.00/ft.
19-0005-99 \$6.30/ft.	32-0225-20 \$7.50/ea.	33-0349-87 \$1.00/ea.	50-0085-73 \$5.40/ft.	70-0018-99 \$5.40/ft.
19-0006-99 \$6.70/ft.	32-0253-37 \$8.30/ea.	33-0350-87 \$1.80/ea.	50-0097-48 \$10.60/ea.	70-0019-52 \$6.30/ft.
19-0023-73 \$3.49/ft.	32-0263-17 \$3.90/ea.	33-0368-30 \$5.90/ea.	50-0100-99 \$4.00/ft.	70-0060-65 \$7.20/ft.
19-0024-52 \$3.49/ft.	32-0317-52 \$3.00/ea.	33-0395-42 \$2.30/ea.	50-0132-48 \$9.90/ea.	70-0064-57 \$3.40/ft.
20-0042-99 \$5.20/ft.	32-0320-21 \$4.80/ea.	33-0427-42 \$2.60/ea.	50-0133-48 \$9.90/ea.	70-0065-73 \$3.50/ft.
20-0302-99 \$3.20/ft.	32-0328-54 \$14.40/ea.	33-0449-42 \$2.50/ea.	50-0161-85 \$6.40/ft.	70-0066-73 \$5.49/ft.
20-0390-99 \$5.00/ft.	32-0333-20 \$7.20/ea.	33-0459-42 \$2.90/ea.	50-0215-99 \$6.30/ft.	70-0075-57 \$5.80/ft.
20-1389-99 \$5.20/ft.	32-0342-24 \$4.20/ea.	33-0482-42 \$4.50/ea.	50-0219-99 \$5.00/ft.	70-0077-99 \$5.40/ft.
20-1688-99 \$4.40/ft.	32-0352-20 \$3.30/ea.	33-0496-71 \$2.60/ea.	50-0229-11 \$7.90/ea.	70-0079-58 \$3.40/ft.
20-2618-99 \$5.20/ft.	32-0355-37 \$12.10/ea.	33-0507-62 \$3.00/ea.	50-0231-48 \$15.00/ea.	70-0081-67 \$6.20/ft.
27-0090-14 \$5.40/ft.	32-0364-37 \$7.20/ea.	33-0512-44 \$2.80/ea.	50-0232-48 \$12.30/ea.	70-0084-99 \$5.49/ft.
27-0106-30 \$5.40/ft.	32-0365-20 \$4.40/ea.	33-0531-42 \$3.90/ea.	50-0233-48 \$16.30/ea.	70-0095-21 \$18.80/ea.
30-0003-99 \$6.20/ft.	32-0365-37 \$4.00/ea.	33-0542-42 \$4.50/ea.	50-0328-48 \$10.00/ea.	70-0116-99 \$5.40/ft.
30-0014-99 \$6.40/ft.	32-0366-53 \$3.00/ea.	33-0556-15 \$4.20/ea.	50-0329-48 \$13.00/ea.	70-0129-99 \$3.39/ft.
30-0020-99 \$5.80/ft.	32-0369-20 \$2.60/ea.	33-0730-42 \$1.30/ea.	50-0333-99 \$5.80/ft.	70-0129-99-WT \$3.69/ft.
30-0031-99 \$5.40/ft.	32-0390-21 \$4.50/pr.	33-0990-87 \$2.60/ea.	50-0340-99 \$6.20/ft.	70-0140-99 \$4.50/ft.
30-0035-65 \$6.20/ft.	32-0401-45 \$1.90/ea.	33-1285-42 \$2.50/ea.	50-0392-99 \$5.90/ft.	70-0142-52 \$3.49/ft.
30-0044-77 \$5.49/ft.	32-0414-32 \$2.80/ea.	33-1574-71 \$3.20/ea.	50-0393-99 \$7.70/ft.	70-0145-73 \$5.00/ft.
30-0051-99 \$6.99/ft.	32-0421-37 \$6.60/ea.	33-1575-71 \$2.80/ea.	50-0482-99 \$6.40/ft.	70-0155-65 \$6.40/ft.
30-0084-99 \$8.90/ft.	32-0422-20 \$5.20/ea.	33-1576-71 \$2.40/ea.	50-0507-48 \$10.90/ea.	70-0219-73 \$5.30/ft.
30-0085-99 \$7.49/ft.	32-0437-20 \$4.50/ea.	35-0070-87 \$3.20/ea.	50-0528-62 \$5.80/ft.	70-0231-85 \$4.70/ft.
30-0086-99 \$5.40/ft.	32-0438-20 \$2.50/ea.	35-0099-20 \$5.00/ea.	50-0541-37 \$3.40/ft.	70-0236-73 \$5.90/ft.
30-0139-73 \$5.89/ft.	32-0439-20 \$4.60/ea.	35-0171-20 \$3.40/ea.	60-0038-99 \$7.20/ft.	70-0241-57 \$5.40/ft.
30-0144-87 \$2.99/ft.	32-0455-14 \$5.30/ea.	35-0197-31 \$5.80/ea.	60-0047-99 \$4.10/ft.	70-0251-65 \$5.90/ft.
30-0144-87-WT \$3.29/ft.	32-0456-20 \$3.00/ea.	35-0262-20 \$3.30/ea.	60-0054-99 \$5.40/ft.	70-0264-48 \$7.40/ea.
30-0154-57 \$5.40/ft.	32-0464-15 \$6.10/ea.	35-0327-45 \$4.70/ea.	60-0055-52 \$5.40/ft.	70-0265-48 \$19.10/ea.
30-0243-73 \$2.99/ft.	32-0491-21 \$5.30/ea.	35-0369-20 \$3.40/ea.	60-0059-83 \$5.40/ft.	70-0288-99 \$6.20/ft.
30-0243-73-WT \$3.29/ft.	32-0492-14 \$4.60/ea.	35-0402-87 \$4.20/ea.	60-0078-99 \$5.40/ft.	70-0306-58 \$9.80/ft.
30-0244-57 \$43.20/pr.	32-0514-20 \$2.50/ea.	35-0457-45 \$4.30/ea.	60-0082-99 \$5.89/ft.	70-0308-17 \$5.80/ft.
30-0308-99 \$4.00/ft.	32-0537-24 \$3.00/ea.	35-0458-45 \$3.30/ea.	60-0083-99 \$5.50/ft.	70-0311-73 \$5.30/ft.
30-0356-85 \$6.30/ft.	32-0714-41 \$4.30/ea.	35-0515-20 \$4.70/ea.	60-0114-99 \$5.00/ft.	70-0331-73 \$4.80/ft.
30-0436-99 \$6.20/ft.	32-0970-17 \$3.10/ea.	35-0517-45 \$4.60/ea.	60-0121-99 \$6.90/ft.	70-0346-85 \$5.60/ft.
30-0439-99 \$3.49/ft.	32-1058-20 \$0.70/ea.	35-1052-20 \$0.60/ea.	60-0129-58 \$83.80/ea.	70-0353-78 \$43.50/ea.
30-0470-99 \$5.40/ft.	32-1059-20 \$0.70/ea.	35-1053-20 \$0.60/ea.	60-0130-99 \$6.70/ft.	70-0354-70 \$6.30/ea.
30-0478-99 \$5.40/ft.	32-1060-20 \$0.70/ea.	35-1054-20 \$0.60/ea.	60-0133-99 \$6.90/ft.	70-0390-73 \$5.80/ft.
30-0482-41 \$7.29/ft.	32-1061-20 \$0.70/ea.	35-1055-20 \$0.60/ea.	60-0153-99 \$5.00/ft.	70-0411-73 \$5.90/ft.
30-0498-99 \$7.00/ft.	32-1062-20 \$0.70/ea.	35-1056-20 \$0.70/ea.	60-0189-48 \$7.60/ea.	70-0412-85 \$6.90/ft.
30-0507-57 \$5.49/ft.	32-1063-20 \$0.70/ea.	35-1214-20 \$6.90/ea.	60-0216-33 \$2.60/ea.	70-0463-85 \$6.90/ft.
30-0512-99 \$5.50/ft.	32-1064-20 \$0.70/ea.	35-3508-45 \$10.50/ea.	60-0231-11 \$13.50/ea.	70-0489-58 \$5.49/ft.
32-0001-37 \$4.60/ea.	32-1065-20 \$0.70/ea.	40-0015-52 \$5.40/ft.	60-0232-11 \$12.40/ea.	70-0490-85 \$7.60/ft.
32-0002-21 \$4.40/ea.	32-1066-20 \$1.90/ea.	40-0018-99 \$6.29/ft.	60-0235-33 \$5.30/ea.	70-0491-73 \$6.30/ft.
32-0003-21 \$4.30/ea.	32-1067-20 \$0.70/ea.	40-0033-99 \$8.30/ft.	60-0273-99 \$7.60/ft.	70-0492-73 \$7.40/ft.
32-0005-14 \$4.20/ea.	32-1068-20 \$1.30/ea.	40-0036-99 \$8.90/ft.	60-0287-99 \$5.90/ft.	70-0509-99 \$6.30/ft.
32-0023-14 \$5.80/ea.	32-1069-20 \$0.70/ea.	40-0053-99 \$6.20/ft.	60-0411-85 \$6.30/ft.	70-0510-85 \$5.90/ft.
32-0039-14 \$4.50/ea.	32-1070-20 \$1.30/ea.	40-0054-99 \$8.10/ft.	60-0416-99 \$5.40/ft.	70-0518-85 \$5.90/ft.
32-0047-14 \$3.40/ea.	32-1071-20 \$1.30/ea.	40-0083-88 \$11.00/ea.	60-0456-99 \$5.30/ft.	70-0519-85 \$2.39/ft.
32-0050-24 \$3.10/ea.	32-1072-20 \$1.30/ea.	40-0095-99 \$5.40/ft.	60-0463-11 \$16.80/ea.	70-0555-58 \$47.70/pr.
32-0051-24 \$3.30/ea.	32-1073-20 \$0.70/ea.	40-0096-99 \$7.40/ft.	60-0523-99 \$6.20/ft.	70-0570-99 \$6.30/ft.
32-0057-24 \$4.80/ea.	32-1074-20 \$1.30/ea.	40-0162-99 \$6.90/ft.	60-0549-99 \$5.80/ft.	70-0585-58 \$3.40/ft.
32-0062-14 \$6.10/pr.	32-1075-20 \$1.30/ea.	40-0168-73 \$6.30/ft.	60-0551-99 \$6.30/ft.	70-0586-99 \$6.20/ft.
32-0062-20 \$6.10/ea.	32-1076-20 \$1.90/ea.	40-0280-57 \$5.30/ft.	60-0552-99 \$6.30/ft.	70-0587-99 \$6.30/ft.
32-0063-14 \$5.60/ea.	32-1077-20 \$1.30/ea.	40-0359-99 \$5.70/ft.	60-0562-99 \$5.90/ft.	70-0598-99 \$6.20/ft.
32-0064-21 \$3.40/ea.	32-1078-20 \$2.60/ea.	40-0360-99 \$5.70/ft.	60-0566-99 \$5.90/ft.	70-0634-48 \$16.00/ea.
32-0066-20 \$3.10/ea.	32-1079-20 \$3.30/ea.	40-0415-99 \$6.20/ft.	60-0576-99 \$6.30/ft.	70-0645-45 \$10.80/sqft.
32-0098-21 \$4.80/ea.	32-1201-20 \$6.80/ea.	40-0432-99 \$6.60/ft.	60-0578-42 \$8.10/ft.	70-0650-85 \$7.80/ft.
32-0112-20 \$4.50/ea.	33-0003-42 \$2.40/ea.	40-0433-99 \$6.50/ft.	60-0583-58 \$44.89/ea.	70-0651-58 \$40.50/ea.
32-0118-37 \$4.20/ea.	33-0016-45 \$3.10/ea.	40-0435-99 \$7.30/ft.	60-0607-99 \$4.89/ft.	70-0653-99 \$5.70/ft.
32-0132-67 \$3.20/ea.	33-0019-20 \$2.40/ea.	40-0436-99 \$6.60/ft.	60-0651-99 \$6.60/ft.	70-0654-99 \$6.20/ft.
32-0133-21 \$3.90/ea.	33-0031-42 \$2.80/ea.	40-0437-99 \$6.30/ft.	60-0653-99 \$6.99/ft.	70-0660-70 \$7.00/ea.
32-0134-20 \$4.30/ea.	33-0042-42 \$3.10/ea.	40-0475-42 \$6.20/ft.	60-0657-99 \$6.60/ft.	70-0662-69 \$145.40/ea.
	33-0046-42 \$2.60/ea.	40-0477-99 \$5.70/ft.	60-0658-99 \$6.70/ft.	70-0701-99 \$4.00/ft.
	33-0109-71 \$4.80/ea.	40-0479-85 \$6.20/ft.	60-0660-45 \$7.00/ft.	70-0749-60 \$50.90/ea.
	33-0113-42 \$4.10/ea.	40-0480-73 \$5.30/ft.	60-0661-99 \$6.90/ft.	70-0752-58 \$50.79/ea.
	33-0116-42 \$3.50/ea.	40-0484-99 \$7.20/ft.	60-0667-45 \$6.30/ft.	70-0777-99 \$5.40/ft.

# Price List



70-0836-99 \$3.90/ft.	70-1662-99 \$6.70/ft.	70-3154-99 \$6.20/ft.	70-3795-99 \$4.19/ft.	83-0129-73 \$33.49/ea.
70-0839-99 \$6.20/ft.	70-1663-99 \$6.40/ft.	70-3155-99 \$6.40/ft.	70-3800-99 \$5.69/ft.	83-0130-73 \$53.99/ea.
70-0884-99 \$4.00/ft.	70-1693-57 \$5.80/ft.	70-3166-99 \$2.39/ft.	70-3801-99 \$5.49/ft.	83-0131-73 \$20.49/ea.
70-0906-99 \$6.20/ft.	70-1731-99 \$6.90/ft.	70-3167-33 \$21.99/ea.	70-3802-99 \$4.19/ft.	83-0132-73 \$39.49/ea.
70-0957-99 \$4.80/ft.	70-1750-99 \$6.20/ft.	70-3168-33 \$29.89/ea.	70-3803-99 \$4.10/ft.	83-0133-73 \$58.49/ea.
70-0997-99 \$6.30/ft.	70-1776-99 \$5.70/ft.	70-3169-99 \$7.40/ft.	70-3804-61 \$46.40/pr.	83-0134-73 \$52.69/ea.
70-0998-99 \$5.90/ft.	70-1789-99 \$5.40/ft.	70-3170-99 \$6.30/ft.	70-3805-61 \$49.10/pr.	83-0135-73 \$46.19/ea.
70-1028-99 \$5.50/ft.	70-1796-99 \$6.70/ft.	70-3176-99 \$7.50/ft.	70-3807-61 \$42.20/pr.	83-0136-73 \$53.99/ea.
70-1029-99 \$7.20/ft.	70-1798-99 \$7.40/ft.	70-3228-99 \$6.60/ft.	70-3813-99 \$3.19/ft.	83-0137-73 \$46.19/ea.
70-1035-99 \$6.60/ft.	70-1799-99 \$6.60/ft.	70-3245-99 \$5.40/ft.	70-3814-99 \$4.19/ft.	83-0138-73 \$50.49/ea.
70-1036-99 \$7.00/ft.	70-1918-52 \$20.50/ea.	70-3246-99 \$2.99/ft.	70-3824-99 \$3.29/ft.	83-0139-73 \$47.79/ea.
70-1037-99 \$6.60/ft.	70-1919-52 \$53.60/ea.	70-3247-44 \$25.99/ea.	70-3825-99 \$2.99/ft.	83-0140-73 \$47.79/ea.
70-1045-99 \$5.90/ft.	70-1967-33 \$14.40/ea.	70-3248-44 \$37.39/ea.	70-3827-99 \$2.60/ft.	83-1016-73 \$94.89/ea.
70-1085-99 \$5.90/ft.	70-1968-36 \$11.70/ea.	70-3286-99 \$5.80/ft.	70-3829-99 \$3.99/ft.	83-1017-73 \$85.99/ea.
70-1097-44 \$43.40/ea.	70-2092-99 \$5.40/ft.	70-3371-99 \$5.20/ft.	70-3839-99 \$2.50/ft.	83-1018-73 \$86.19/ea.
70-1098-44 \$76.30/ea.	70-2093-99 \$6.29/ft.	70-3425-52 \$28.90/ea.	70-3846-99 \$1.99/ft.	83-1019-73 \$99.99/ea.
70-1099-44 \$41.80/ea.	70-2118-99 \$3.39/ft.	70-3456-99 \$101.49/ea.	70-3847-99 \$3.19/ft.	83-1020-73 \$99.99/ea.
70-1100-44 \$76.30/ea.	70-2119-99 \$2.99/ft.	70-3570-58 \$27.69/ea.	70-3848-99 \$2.29/ft.	83-1021-73 \$99.99/ea.
70-1101-44 \$43.40/ea.	70-2124-99 \$5.70/ft.	70-3571-58 \$52.69/ea.	70-3849-99 \$2.69/ft.	83-1022-73 \$90.99/ea.
70-1102-44 \$76.30/ea.	70-2166-99 \$3.30/ft.	70-3572-58 \$26.19/ea.	70-3850-99 \$5.19/ft.	83-1023-85 \$17.69/ea.
70-1105-99 \$2.99/ft.	70-2169-57 \$3.99/ft.	70-3573-58 \$23.49/ea.	70-3851-99 \$3.69/ft.	83-1024-85 \$31.89/ea.
70-1105-99-WT \$3.29/ft.	70-2170-57 \$4.29/ft.	70-3574-58 \$38.29/ea.	70-3852-99 \$2.99/ft.	83-1025-85 \$43.99/ea.
70-1106-99 \$3.19/ft.	70-2195-52 \$23.70/ea.	70-3575-58 \$24.99/ea.	70-3854-99 \$3.49/ft.	83-1026-85 \$79.69/ea.
70-1106-99-WT \$3.49/ft.	70-2196-52 \$56.40/ea.	70-3576-58 \$21.99/ea.	70-3855-99 \$3.29/ft.	83-1027-73 \$28.89/ea.
70-1107-57 \$41.40/ea.	70-2221-42 \$8.10/ft.	70-3577-58 \$29.89/ea.	70-3857-99 \$4.19/ft.	83-1028-73 \$82.49/ea.
70-1108-57 \$49.10/ea.	70-2232-48 \$10.70/ea.	70-3578-58 \$30.99/ea.	70-3858-99 \$4.19/ft.	83-1029-73 \$28.89/ea.
70-1111-73 \$5.50/ft.	70-2233-48 \$10.70/ea.	70-3579-58 \$21.49/ea.	70-3859-99 \$2.99/ft.	83-1030-73 \$82.49/ea.
70-1112-73 \$7.40/ft.	70-2234-48 \$10.50/ea.	70-3580-58 \$47.49/ea.	70-3872-99 \$4.00/ft.	83-1031-73 \$31.99/ea.
70-1114-57 \$3.99/ft.	70-2241-99 \$6.40/ft.	70-3581-99 \$6.99/ft.	70-3885-99 \$3.29/ft.	83-1032-73 \$92.19/ea.
70-1115-57 \$4.69/ft.	70-2253-99 \$6.60/ft.	70-3582-99 \$4.99/ft.	70-3888-99 \$3.99/ft.	83-1033-73 \$28.89/ea.
70-1120-61 \$42.40/ea.	70-2324-57 \$5.20/ft.	70-3583-99 \$4.99/ft.	70-3889-99 \$5.00/ft.	83-1034-73 \$82.49/ea.
70-1121-61 \$46.40/pr.	70-2329-99 \$6.20/ft.	70-3584-99 \$7.49/ft.	70-3890-99 \$5.00/ft.	83-1035-73 \$30.99/ea.
70-1125-33 \$5.60/ea.	70-2393-99 \$5.80/ft.	70-3585-99 \$176.39/ea.	70-3897-99 \$5.30/ft.	83-1036-73 \$88.99/ea.
70-1163-52 \$3.49/ft.	70-2394-99 \$6.20/ft.	70-3586-99 \$172.19/ea.	70-3898-99 \$3.60/ft.	83-1037-73 \$14.99/ea.
70-1167-99 \$5.90/ft.	70-2396-99 \$5.49/ft.	70-3587-99 \$142.19/ea.	70-3899-99 \$4.90/ft.	83-1038-73 \$29.99/ea.
70-1168-58 \$9.80/ft.	70-2401-99 \$5.30/ft.	70-3588-99 \$124.49/ea.	70-3983-99 \$1.40/ft.	83-1039-73 \$82.49/ea.
70-1169-58 \$9.70/ft.	70-2422-99 \$5.49/ft.	70-3590-99 \$4.99/ft.	70-3984-99 \$3.20/ft.	83-1040-73 \$14.99/ea.
70-1170-99 \$5.40/ft.	70-2423-99 \$5.49/ft.	70-3591-99 \$4.99/ft.	82-0030-99 \$5.70/ft.	83-1041-73 \$29.99/ea.
70-1171-99 \$5.90/ft.	70-2424-99 \$4.99/ft.	70-3592-99 \$5.29/ft.	82-0216-99 \$6.60/ft.	83-1042-73 \$82.49/ea.
70-1188-52 \$5.40/ft.	70-2642-57 \$4.30/ft.	70-3593-99 \$183.79/ea.	83-0102-73 \$19.19/ea.	83-1046-73 \$14.99/ea.
70-1189-52 \$6.30/ft.	70-2674-42 \$38.39/ea.	70-3594-99 \$146.79/ea.	83-0103-73 \$32.99/ea.	83-1047-73 \$29.99/ea.
70-1190-52 \$5.50/ft.	70-2675-42 \$54.89/ea.	70-3595-99 \$153.49/ea.	83-0104-73 \$17.89/ea.	83-1048-73 \$82.49/ea.
70-1191-52 \$5.40/ft.	70-2684-42 \$34.99/ea.	70-3596-99 \$2.99/ft.	83-0105-73 \$32.19/ea.	83-1049-73 \$14.99/ea.
70-1192-52 \$5.40/ft.	70-2685-42 \$52.99/ea.	70-3597-99 \$2.99/ft.	83-0106-73 \$45.79/ea.	83-1050-73 \$29.99/ea.
70-1193-99 \$5.40/ft.	70-2705-99 \$5.20/ft.	70-3598-99 \$4.49/ft.	83-0107-73 \$21.39/ea.	83-1051-73 \$82.49/ea.
70-1194-52 \$5.40/ft.	70-2727-99 \$5.40/ft.	70-3599-99 \$3.29/ft.	83-0108-73 \$38.99/ea.	94-0100-94 \$57.40/ea.
70-1195-52 \$5.40/ft.	70-2746-99 \$4.79/ft.	70-3600-99 \$3.99/ft.	83-0109-73 \$20.99/ea.	94-0101-94 \$26.50/ea.
70-1236-48 \$4.00/ft.	70-2813-60 \$20.79/ea.	70-3601-99 \$3.29/ft.	83-0110-73 \$38.99/ea.	94-0102-94 \$24.10/ea.
70-1237-48 \$4.20/ft.	70-2814-60 \$38.39/ea.	70-3602-99 \$3.49/ft.	83-0111-73 \$53.99/ea.	94-0104-94 \$46.90/ea.
70-1238-58 \$44.30/ea.	70-2815-60 \$54.89/ea.	70-3647-99 \$5.40/ft.	83-0113-73 \$33.39/ea.	94-0106-94 \$44.90/ea.
70-1239-58 \$48.20/ea.	70-2816-60 \$22.29/ea.	70-3658-99 \$6.20/ft.	83-0114-73 \$49.99/ea.	94-0107-94 \$16.50/ea.
70-1244-73 \$5.90/ft.	70-2817-60 \$43.29/ea.	70-3672-99 \$2.99/ft.	83-0115-73 \$31.89/ea.	94-0108-94 \$21.80/ea.
70-1245-73 \$7.20/ft.	70-2818-60 \$55.89/ea.	70-3673-99 \$2.99/ft.	83-0116-73 \$47.99/ea.	94-0109-94 \$7.80/ea.
70-1258-99 \$5.80/ft.	70-2820-60 \$21.89/ea.	70-3676-99 \$2.99/ft.	83-0118-73 \$98.79/ea.	94-0110-00 \$3.19/ea.
70-1260-99 \$6.30/ft.	70-2821-60 \$40.49/ea.	70-3677-99 \$2.99/ft.	83-0119-73 \$49.99/ea.	96-0495-96 \$9.79/ea.
70-1261-99 \$6.70/ft.	70-2822-60 \$57.99/ea.	70-3680-99 \$5.40/ft.	83-0120-73 \$26.49/ea.	96-8001-96 \$14.49/ea.
70-1267-99 \$5.70/ft.	70-2831-99 \$6.49/ea.	70-3703-99 \$1.40/ft.	83-0121-73 \$39.29/ea.	96-8008-96 \$19.49/ea.
70-1269-99 \$5.30/ft.	70-2841-99 \$2.80/ft.	70-3708-99 \$2.99/ft.	83-0122-73 \$53.99/ea.	96-8011-96 \$19.49/ea.
70-1292-73 \$6.30/ft.	70-2844-57 \$5.50/ft.	70-3709-99 \$4.29/ft.	83-0123-73 \$50.29/ea.	96-8061-96 \$19.69/ea.
70-1297-99 \$5.50/ft.	70-2850-52 \$41.79/ea.	70-3710-99 \$4.79/ft.	83-0124-73 \$50.29/ea.	96-8080-96 \$29.49/ea.
70-1428-99 \$6.60/ft.	70-2851-52 \$28.49/ea.	70-3711-99 \$4.49/ft.	83-0125-73 \$21.49/ea.	96-8509-96 \$18.99/ea.
70-1437-99 \$5.30/ft.	70-2856-99 \$3.70/ft.	70-3712-99 \$4.19/ft.	83-0126-73 \$39.19/ea.	96-8984-96 \$30.49/ea.
70-1446-99 \$5.10/ft.	70-2860-52 \$41.79/ea.	70-3714-99 \$177.19/ea.	83-0127-73 \$17.49/ea.	96-8987-96 \$29.69/ea.
70-1448-73 \$6.50/ft.	70-2863-58 \$6.39/ft.	70-3716-99 \$186.39/ea.	83-0128-73 \$17.79/ea.	
70-1583-99 \$6.99/ft.	70-2989-99 \$5.40/ft.	70-3782-99 \$2.49/ft.		
70-1644-99 \$5.80/ft.	70-2992-99 \$5.70/ft.	70-3788-99 \$2.49/ft.		
70-1656-99 \$4.60/ft.	70-3113-99 \$5.40/ft.	70-3794-99 \$4.19/ft.		

ASK ABOUT PRICE DISCOUNTS FOR DENSE AND SPONGE  
EXTRUSION ORDERS OF 50ft+, 100ft+, & 250ft+

**Call 800-230-5871 to order**

or to inquire about pricing for any parts not listed here



toll free 800-230-5871 • [www.steelerubber.com](http://www.steelerubber.com)

## Customer Service

Steele provides quality service both before and after your purchase. To place orders, check order status, request a catalog or for any other inquiries, contact us Mon-Friday 8am-6pm Eastern Standard Time at 800-230-5871 (toll free) or 704-483-9343 (local). You can also contact us 24/7 at [contact@steelerubber.com](mailto:contact@steelerubber.com)

## Return Policy

To request a return for something you've purchased from Steele Rubber Products, contact us directly Monday-Friday 8am-6pm at 800-461-7089 (toll free) or 704-483-9343 (local). Our product specialist will provide you with a return merchandise authorization number (RMA) and instructions for returning part(s) to us.

### Note:

Parts are accepted for return only in the units purchased and with the original invoice.

We cannot accept refund packages sent COD or any method for which there is a charge to us.

If a part is altered or damaged in any way, we will not be able to accept it for return. We cannot accept returns of products not purchased directly from Steele Rubber Products. Shipping and handling charges are not refundable. To view our full return policy visit: <https://www.steelerubber.com/returns-and-exchanges>

## Parts Availability

New parts are constantly added to our inventory. Visit us online for current availability of all products.

## Delivery of Parts

We cannot guarantee a continuous roll of any extrusion in this catalog when ordered in bulk. Therefore, we reserve the right to deliver your parts in multiple lengths to meet your total purchase requirements. We will do our best to ensure that each strip is as long as possible to minimize scrappage for you.

## Use of Parts

These parts are not recommended for specific usage. We are not responsible for damages caused by incorrect installation, abuse, mishandling, accidents or normal wear. Nor will Steele be responsible for labor charges, inconveniences, or any other expenses associated with parts bought through resellers or Steele Rubber Products.

## Satisfaction Guarantee:

We offer a 100% satisfaction guarantee on all parts manufactured by and purchased from Steele Rubber Products.

## Copyright Section

Contents 2019© Steele Rubber Products, Inc. Printed in the USA. This catalog may not be reproduced without written permission. All drawings, photographs, and graphic images contained in this catalog are the property of Steele Rubber Products and cannot be reproduced without written permission. The contents of this catalog should not be altered in any way for commercial or other use.

## Payment Information



\*\* For full disclosure of Steele Rubber Products policies please visit us online at <https://www.steelerubber.com>. If you do not have access to the internet and would like a printed version of our policies, please call 800-230-5871 (toll free) or 704-483-9343 (local).